



# Zip HydroTap® G4

The Worlds most advanced Drinking Water Appliance

Model:

Command Centre (see table of contents for specific models)



**VENTILATION  
IS ESSENTIAL**  
READ SECTION 1  
'VENTILATION'  
BEFORE YOU START

## HydroTap G4 specifications

Important safety instructions .....	3
Warnings and regulatory information .....	4
Installation check list .....	5
General product features .....	7
Tap options.....	8
Major components and accessories.....	9
Tap - Command Centre compatibility.....	10
Technical specifications .....	12
Before installation and site requirements.....	13

## Installation instructions

**Step 1** - Measure and cut all the tap holes, fit the taps : Refer to 803341 Tap installation instructions.

**Step 2** - Check for adequate ventilation.

Section 1 - Ventilation.

Section 1.1 - 1.6 Ventilation for all models.....	14
---	----

**Step 3** - Install the booster / scale filter / water block / carbonation valve (if required).

Section 2 - Booster installation.....	23
Section 3 - Scale filter installation .....	25
Section 4 - CO <sub>2</sub> cylinder installation .....	26
Section 5 - Water block installation .....	28
Section 6 - Carbonation valve installation .....	30

**Step 4** - Install the Command Centre.

Section 7 Commercial & residential Command Centre installation.

Section 7.1 - Generic Command Centre installation instructions .....	31
Section 7.2 - External bypass valve.....	32
Section 7.3 - 5253UK & 5053UK BCS commercial installation.....	34
Section 7.4 - 2957UK, 2857UK, 1456UK & 1256UK BCS comm. and res. compact installation.....	39
Section 7.5 - 5261UK & 5061UK BC commercial installation.....	44
Section 7.6 - 2924UK, 2824UK, 1414UK & 1214UK BC comm. and res. compact installation.....	49
Section 7.7 - 5200UK, 5201UK, 5000UK, 5001UK, 1500UK, 1300UK, BO, BA installation .....	54
Section 7.8 - 0053UK CS commercial installation .....	61
Section 7.9 - 0061UK C commercial installation .....	64

**Step 5** - Commission the HydroTap G4.

Section 8 - Commissioning

Section 8.1 - Warnings and precautions .....	67
Section 8.2 - Basic guidelines.....	67
Section 8.3 - Select the language .....	68
Section 8.4 - CO <sub>2</sub> purge.....	68
Section 8.5 - Filter flush .....	68
Section 8.6 - Boiling calibration.....	68
Section 8.7 - Booster enable.....	69
Section 8.8 - Safety sensor calibration .....	69
Section 8.9 - System flush.....	69

## Trouble shooting and general maintenance

Trouble shooting table .....	71
General maintenance .....	71
End of life disposal.....	72
Warranty.....	73
Contact details.....	76



This manual contains important safety and installation instructions for the Zip HydroTap G4. Please read all warnings, installation requirements and installation instructions before installing any Zip HydroTap G4. This system must be installed in accordance with water supply byelaws, current IEE regulations and relevant local authority byelaws.

### Safety

The HydroTap G4 can be used by children aged 8 years and above and persons with reduced physical, sensory or mental capabilities or lack of experience and knowledge if they have been given supervision or instruction concerning use of it in a safe way and understand the hazards involved. Children shall not play with the HydroTap G4. Cleaning and user maintenance shall not be made by children without supervision.

### Refrigerant

The Zip HydroTap G4 Command Centre contains R134A refrigerant under pressure. Maintenance of the refrigeration must be carried out by an accredited service provider or qualified refrigeration technician.

### CO<sub>2</sub>

You can have serious health problems if breathing air containing concentrations of CO<sub>2</sub> up to 15000ppm (1.5%) for more than 10 minutes. Proper ventilation must be provided to ensure that, in case of escape, concentrations of CO<sub>2</sub> remain below this level.

### Qualifications

If the power cable is damaged it must be repaired only by a qualified technician. To avoid hazards, all installation procedures must be carried out by a suitably qualified trades person. The power cable and power outlet must be in a safe visible position for connection.

### Venting

Steam and / or boiling water droplets may sometimes discharge through a vent outlet on the tap. If the tap is not installed using the font, ensure the tap body is located so the tap outlet safely dispenses into the sink bowl area.

### Lifting

Take care when lifting. The Command Centre may exceed safe lifting limits. If you feel this is beyond your personal capabilities, please seek assistance with the lift. The weight of the Command Centre is marked on the packaging. Do not lift the Command Centre by the front cover or any of its connections. Refer to the technical specification, see page 12, for the weight of the product.

### Airflow

The Zip HydroTap G4 operates within the ambient temperature range 5°C - 35°C. Proper air circulation must be provided. The system will operate satisfactorily only if the recommended air gaps are provided. See Section 1 'Ventilation', page 14, for correct installation to prevent overheating. The vent kit supplied must be fitted.

### Altitude

Water boils at varying temperatures at different altitudes. The HydroTap G4 adjusts for this during startup calibration and will recalibrate itself on a regular basis.

### Frost protection

If the HydroTap G4 is located where the ambient air temperature could fall below 5°C when not in use, do not turn off the HydroTap G4 electrically. This safeguard does not offer the same protection to the connecting pipework and fittings.

### Positioning

It is important to ensure the Command Centre is positioned in an accessible area close to the floor level. The Command Centre must have its base mounted in a horizontal position with all inlets and outlets facing up. The tap must be located above the Command Centre. See Section 7, Command Centre installation.

## WARNINGS AND REGULATORY INFORMATION

### Warnings



- ⚡ The Zip HydroTap G4 must be earthed. The resistance of the earth connection from each exposed metal part must be less than 1Ω.
- All installation and service work must be completed by trained and suitably qualified tradespeople. Faulty operation due to unqualified persons working on this product, or any other Zip product may void warranty coverage.
- As the installer, it is your responsibility to supply (if necessary) and install all valves as required by local regulations and relevant standards.
- The HydroTap G4 is rated for 230V 50/60Hz AC operation (supply frequency dependant upon model purchased).
- Do not remove the cover of the Command Centre under any circumstances without first isolating from the power supply.
- Never locate the Command Centre near, or clean with water jets.
- Do not expose the Zip HydroTap G4 to the elements of nature.
- Due to the process of continuous improvement, Zip reserves the right to change details mentioned in this manual, without notice.
- Visit [www.zipwater.co.uk](http://www.zipwater.co.uk) to ensure you have the latest copy of this document.



### Do not fill until ready for use

- For safe operation, the HydroTap G4 is designed to be installed, commissioned and used within 48 hours. Should the HydroTap G4 not be required for an extended period of time, 72 hours or more, do not fill and commission the HydroTap G4 until ready for first use.



### Sanitise during commissioning

- All HydroTap G4 models with chilled; ambient and/or sparkling functionality must be sanitised during the commissioning process, please contact Zip on 0345 6 005 005 to book your free commissioning service.

## Installation checklist

- Please read these instructions carefully before commencing installation of the Zip HydroTap G4.
- Please leave these instructions with the end user after installation.

### Before installation

- Read the instructions and check if there is adequate space to install all of the components.
- **Note** Not all fittings are supplied with the HydroTap G4. Isolation valves are not supplied.
- Check the mains water pressure is within min / max requirements (see page 12).
- Check the water quality to determine if extra filtration will be required.
- **Note** This HydroTap G4 must be fitted to a wholesome water supply.
- Check the Command Centre rating plate and ensure correct power is available.
- Check the under counter cupboard floor supporting the Command Centre is adequate for its total weight, when full of water.

### Before commissioning

All Zip G4 HydroTap G4 models with chilled; ambient and/or sparkling functionality must be sanitised during the commission process, please contact Zip to book a free commissioning service.

- Do not commission the HydroTap G4 until ready for use.
- Ensure the HydroTap G4 is sanitised before use. See Warnings and regulatory information page 4 and 5.
- Check the system has been installed correctly.

## Installation checklist

- Check all plumbing fittings for water tightness.
- Ensure the outlet and vent pipes are positioned to drain correctly.
- Ensure there is adequate ventilation.
- Check all tubes and pipes from the Command Centre to the tap have a constant rise and there are no sags or kinks in the tubes and hoses.
- Check all electrical connections are correct and there are no loose wires.

### **Commission** (see section 8)

- Flush the supply line before connecting.
- Turn on the water and check for leaks.
- Flush the filter(s).
- Activate / enable the booster (if fitted).
- Calibrate the safety sensor for boiling models.
- Where applicable, programme the Command Centre to suit the customer's requirements.

## General product features

Thank you for purchasing a Zip HydroTap G4. Please read and follow these instructions carefully to ensure safe and trouble free operation. If help and advice is required, please call 0345 6 005 005.

### What is the Zip HydroTap G4 ?

This Zip HydroTap G4 is an electronically controlled, filtered, boiling, chilled and sparkling (functionality is dependant upon model purchased) drinking water system for the kitchen. The HydroTap G4 comprises a under counter drinking water command centre with a dispensing tap mounted on a sink or worktop, which have been designed for commercial or residential applications. The HydroTap G4 utilises a conventional refrigerant compressor to chill the water and an immersion heating element to boil the water. The HydroTap G4 is NOT designed to be used solely as sanitary fixtures. The Zip HydroTap G4 models which dispense boiling water are fitted with a tap mounted safety lock. In addition, there are various energy saving options accessible via the main menu. The system is equipped with a self-calibrating program which caters for altitude adjustment. The water filter is a disposable item which will require periodic replacement and is covered by a limited OEM warranty. It is important that the installation be undertaken safely, correctly and completely in order to utilise all the benefits that the HydroTap G4 can provide. HydroTap G4 Classic taps can be ordered with the tap head assembly for disabled use. The disabled levers are supplied with Braille caps for the visually impaired.



Command Centre

## Tap options

The G4 series offers a range of interchangeable taps to suit the customer's needs.



Classic range



Arc / Cube range



Mixer range



All-in-One range



Celsius range

These standalone taps offer instant boiling, chilled and sparkling water\* and are directly compatible with the G4 Command Centre.

The mixer tap range may be used in conjunction with either of the above to provide mixed hot and cold water for sanitary use\*.

The All-in-One tap may be used as alternatives to the above HydroTap and mixer tap combinations\*.



The Celsius range offer instant boiling, chilled and sparkling / boiling and chilled / boiling and ambient / chilled and sparkling / chilled or boiling\* water together with an integral mixer to provide mixed hot and cold water from the mains.

\*Dependant upon model purchased.

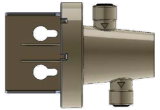

## Major components and accessories

Parts supplied	Description
<b>Tap options*</b>	
	1 x HydroTap G4
	1 x All-in-One HydroTap G4 Mains or Vented
	1 x mixer tap
<b>Command Centre and components</b>	
	Duct kit* 1 x Exhaust duct 1 x Mounting plate 2 x Outlet vent 1 x Inlet vent
	1 x Command Centre with air and water filters
	1 x Mains water connection hose
	1 x Booster inc. connection hoses (supplied with 140 or 240 models)
	1 x Installation fittings (supplied with vented mixer tap models)
	1 x User guide and 1 x Quick start guide 1 x Installation instruction

Accessories	Description
	Booster (inc. connection hoses)
	Scale, taste & odour filter
	Scale filter installation kit (Filter not included).
	Font, Integrated or Stand alone
	Replacement internal 0.2 micron filter
	Disabled lever kit (Classic HydroTap)
	Mixer upgrade
	All-in-One upgrade (vented) (mains)
	Recommended water block

For Accessories contact Zip:  
Tel 0345 6 005 005  
Website: [www.zipwater.co.uk](http://www.zipwater.co.uk)  
Email: [sales@zipindustries.co.uk](mailto:sales@zipindustries.co.uk)

\*Dependant on model purchased.

## Commercial B, BA, BC and BCS HydroTap G4 range

### HydroTaps

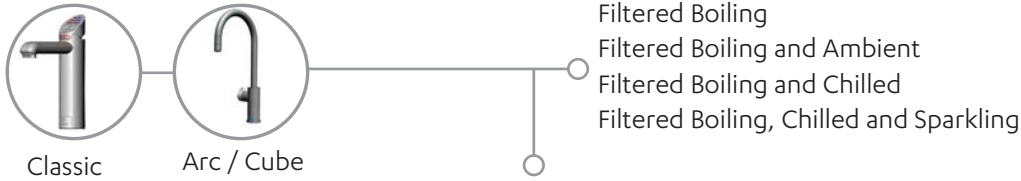

### Mixer tap



### All-in-One Classics

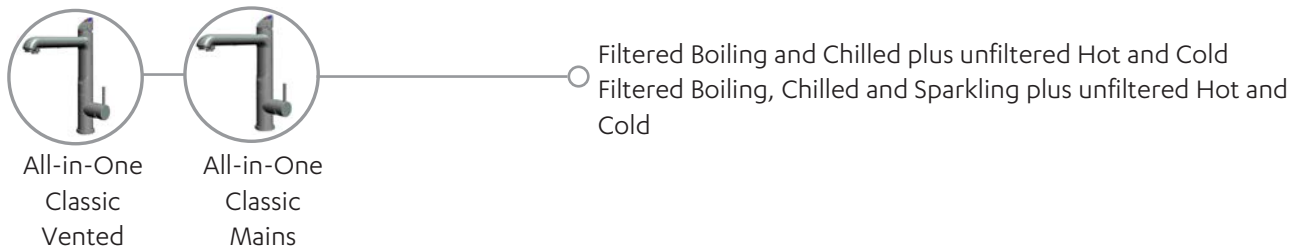

### Celsius & All-in-One Celsius Arc

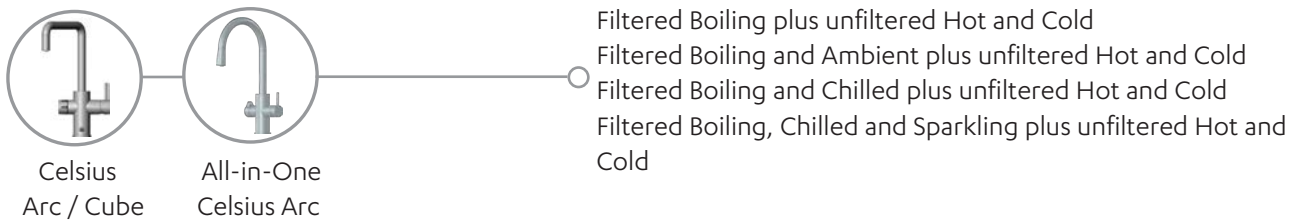

## Commercial C and CS HydroTap G4 range

### HydroTaps



### Celsius

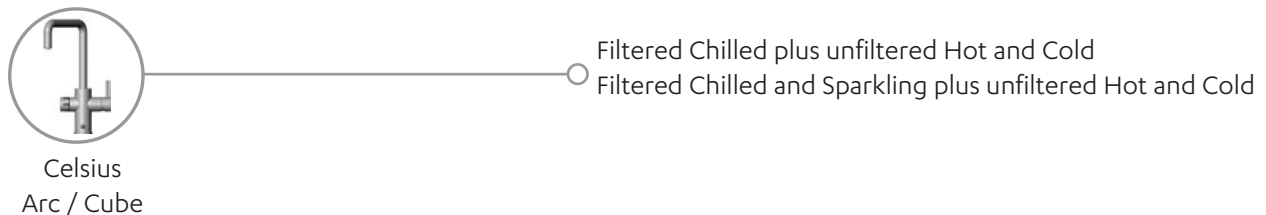

## Residential B, BC and BCS HydroTap G4 range

### HydroTaps

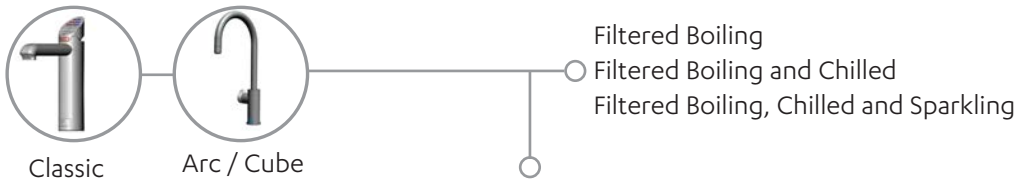

### Mixer taps



### All-in-One taps

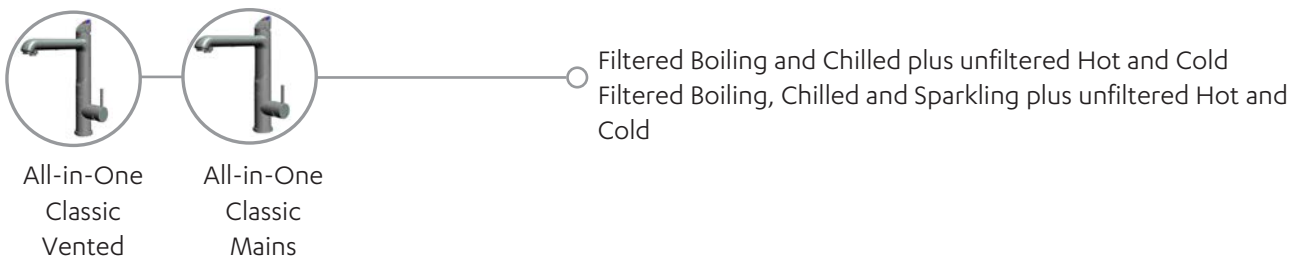

### Celsius & All-in-One Celsius Arc

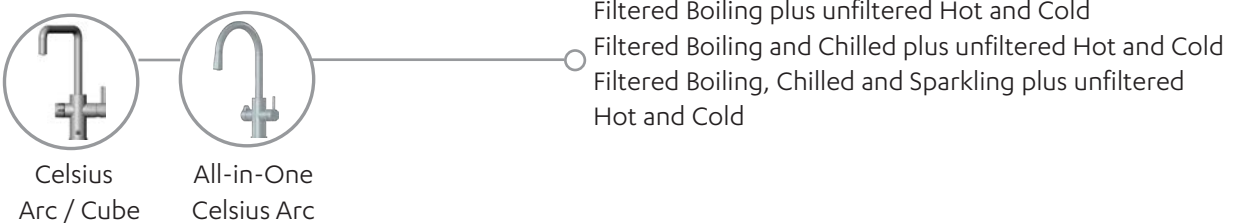

## Technical specifications

Command Centre	Capacity boiling (167ml cups/hr)	Capacity chilled/sparkling (200ml glasses/hr)	Power rating (kW) 230V	Boost rating (kW) 230V	Boost (10A)	**13A sockets required	Unit Dimensions**** W x D x H (mm) with air duct	***Dry weight (kg)
----------------	----------------------------------	---	------------------------	------------------------	-------------	------------------------	--	--------------------

### Commercial Command Centres

#### Filtered Boiling, Chilled and Sparkling, with and without booster

5253UK# 5053UK	160 / 240*	175	2.30	2.20	optional	1 / 2*	450 x 470 x 335	39
2957UK# 2857UK	100 / 140*	75	2.13	2.20	optional	1 / 2*	338 x 461 x 335	30

#### Filtered Boiling and Chilled, with and without booster

5261UK# 5061UK	160 / 240*	175	2.13	2.20	optional	1 / 2*	450 x 470 x 335	28
2924UK# 2824UK	100 / 140*	75	2.05	2.20	optional	1 / 2*	280 x 470 x 335	22

#### Filtered Boiling and Ambient, with and without booster

5201UK# 5001UK	160 / 240*	-	1.90	2.20	optional	1 / 2*	280 x 313 x 335	13
-------------------	------------	---	------	------	----------	--------	-----------------	----

#### Filtered Boiling, with and without booster

5200UK# 5000UK	160 / 240*	-	1.90	2.20	optional	1 / 2*	280 x 313 x 335	11
-------------------	------------	---	------	------	----------	--------	-----------------	----

#### Filtered Chilled and Sparkling

0053UK	-	175	0.45	-	-	1	336 x 476 x 335	36
--------	---	-----	------	---	---	---	-----------------	----

#### Filtered Chilled

0061UK	-	175	0.3	-	-	1	336 x 480 x 335	24
--------	---	-----	-----	---	---	---	-----------------	----

### Residential Command Centres

#### Filtered Boiling, Chilled and Sparkling, with and without booster

1456UK# 1256UK			1.7	2.2	optional	1 / 2*	338 461 x 335	30
-------------------	--	--	-----	-----	----------	--------	---------------	----

#### Filtered Boiling and Chilled, with and without booster

1414UK# 1214UK			1.55	2.2	optional	1 / 2*	280 x 470 x x335	21
-------------------	--	--	------	-----	----------	--------	------------------	----

#### Filtered Boiling, with and without booster

1500UK# 1300UK			1.43	2.2	optional	1 / 2*	280 x 313 x 335	11
-------------------	--	--	------	-----	----------	--------	-----------------	----

# Supplied with venturi for vented mixer tap

\* With boost

\*\* One for the Command Centre, and one for the booster

\*\*\* Add 3 - 8Kg when full

\*\*\*\* Refer to Section 7, Command Centre installation, for clearance envelope.

## Water supply pressure requirements

Component	Min. / Max. water supply pressure MPa (bar) (in a G4 HydroTap system)
HydroTap	0.17 (1.7) - 0.5 (5.0)
Sparkling HydroTap	0.25 (2.5) - 0.5 (5.0)
Mixer tap	0.20 (2.0) - 0.5 (5.0)
Booster	0.20 (2.0) - 0.5 (5.0)
Scale filter	0.20 (2.0) - 0.5 (5.0)



**Before installation ensure that the following have been provided at the installation site**

- Review of all the technical specifications.
- Ensure the under counter cupboard floor can support the Command Centre weight when full of water (allow an extra 3-8kg when full).
- Sufficient space in the cupboard to install the Command Centre and other components in accordance with these installation instructions. See Technical specification, page 12 for dimensions. Make allowance for a booster if required. See sections 2 page 23 for installation instructions.
- For Zip HydroTap G4 models without booster, 1 x 220-240V AC 13A socket will be required.
- For Zip HydroTap G4 models with booster, 2 x 220-240V AC 13A sockets will be required. (One socket is for the Command Centre and the other for the booster).
- Both the Command Centre and booster must be installed in accordance with IEE regulations, See Technical specification, page 12 for power ratings.

**Note** Check all cable and hose lengths against inlet /outlet positions before proceeding (see section 7 for general layout).

- A wholesome water supply connection with a minimum working pressure of: (see page 12 min. / max. water supply pressure) with isolating valve inside the cupboard within reach of the braided hoses and positioned so that the connection point and the stop cock will not be obstructed when the Command Centre is installed.
- For the All-in-One, Celsius and Mains mixer taps a hot and cold water supply are required. (See page 12 for min/max. water supply pressure).
- If external filtration or a lime-scale protection filter is required, then it is important to allow extra space for it.
- If pressure is likely to exceed 0.5 MPa (5 bar), install a 0.35 MPa (3.5 bar) pressure limiting valve.
- The command centre must be placed with its base in a horizontal position.
- Ensure proper ventilation for CO<sub>2</sub>, see Important safety instructions, page 4.

**IMPORTANT!** Do not proceed with the installation if these requirements are not met.

# Section 1 Ventilation

## Ventilation table of contents

1.1 Generic requirements .....	13
1.2 BC, BCS Commercial Command Centre installation .....	14
1.3 BC, BCS Commercial compact Command Centre installation .....	16
1.4 BO, BA Commercial and BO Residential Command Centre installation .....	17
1.5 CS, C Commercial Command Centre installation .....	18
1.6 BC, BCS Residential Command Centre installation .....	20

## Generic requirements

### 1.1 Generic requirements



**Important** Read this section in conjunction with section 7 Command Centre installation, page 31.

#### When installing air flow vents, the following tools will be required

- Jigsaw and drill or equivalent equipment.
- Keyhole or wall board saw.

#### Clearance envelope



- A clearance envelope around all Command Centres must be provided to allow adequate ventilation for the safe and effective use of the HydroTap G4 system.

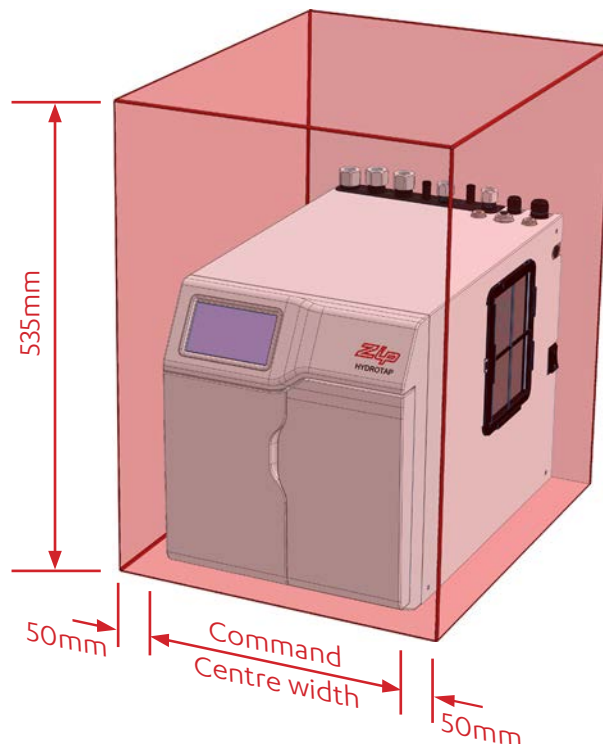

## 1.2 BC, BCS Commercial Command Centres

### 1.2.1 Ventilation for all models

- The clearance envelope dimensions stated in the Specification sheets and Installation instructions must be observed.
- Adequate ventilation must be provided to ensure that the cupboard temperature doesn't exceed 35°C.

### 1.2.2 Preferred ventilation arrangement shown below

The ducted vent kit supplied with the Command Centre exhausting through the kick-space should be used, to provide adequate ventilation in all conditions. (Ancillary components are not shown in these diagrams).

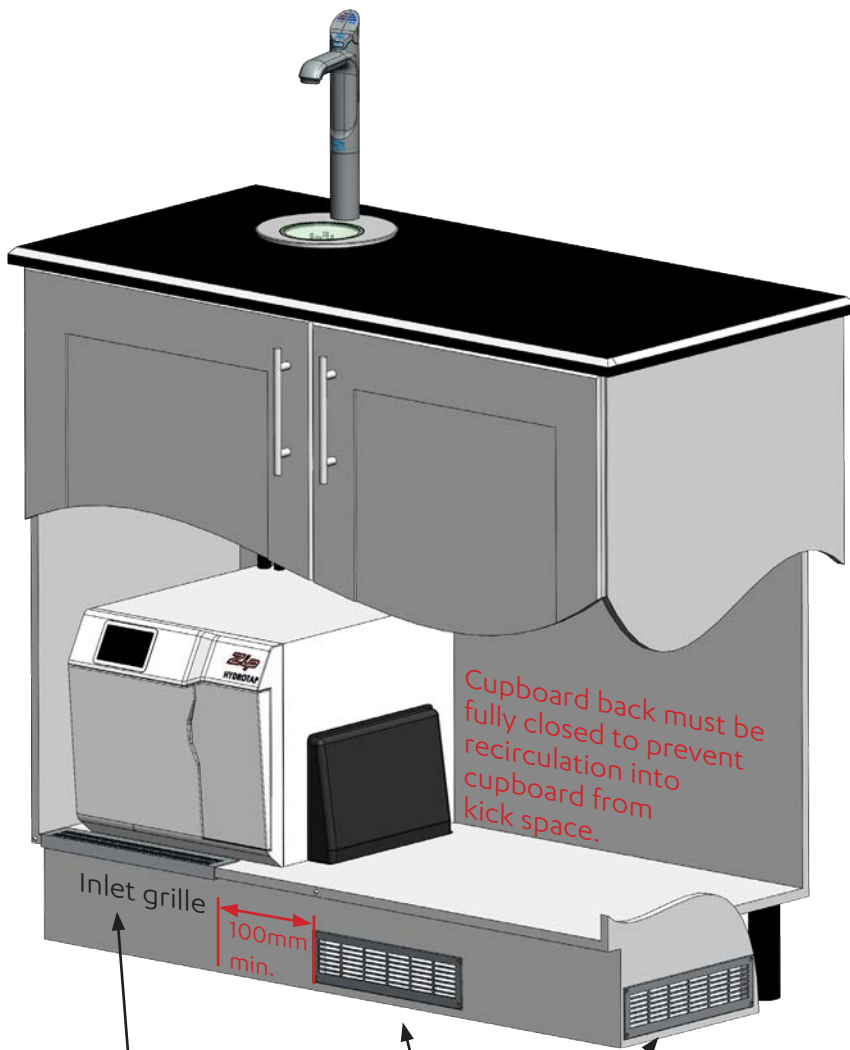

Inlet grille should be fitted in baseboard

Position vent grille on either the kick board or the cupboard ends

### Vent cut-out details

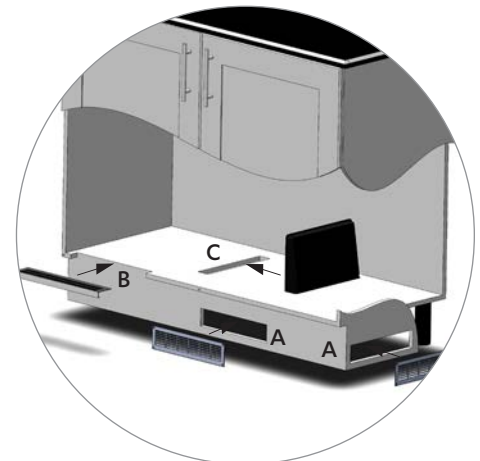
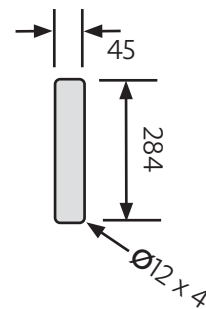
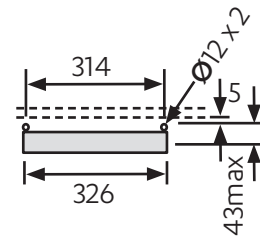
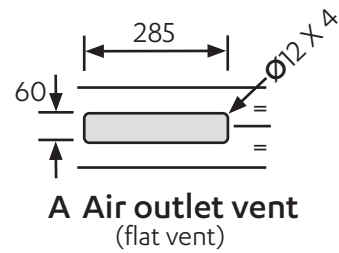

### 1.2.3 Alternative arrangement (Dual fan kit)

In situations where the preferred arrangement cannot be used or will not work effectively e.g.

- Single cupboard where the 100mm grille spacing cannot be achieved.
- Where there are openings in the back of the cupboard allowing exhaust air to recirculate into the cupboard space.

An SP93156 Dual exhaust fan kit\* must be fitted in either arrangement A or B shown below and connected to the DIN socket on the Command Centre.

**A** Fan kit fitted to kick board and with kick space duct fitted to the Command Centre.

**B** Fan kit fitted to cupboard door (position **B1**) or side (position **B2**) and without kick space duct fitted to the Command Centre.

\*For dual exhaust fan cut-out dimensions see the instructions provided with the kit.

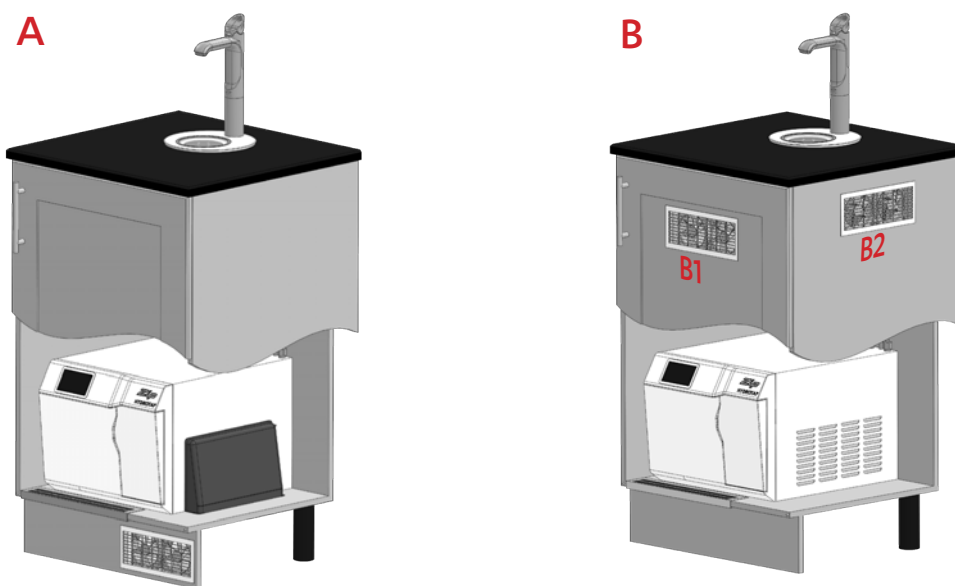

### 1.2.4 Alternative arrangement (Vent tray)

In situations where cupboard width is 1000mm or greater, without central pillar or where the rear of the cupboard is not sealed and where vent grilles cannot be fitted in the kick board (e.g. hospitals) use a **Vent tray kit** Call Zip on 0345 6 005 005.

A vent grille, supplied should be used as an inlet vent and fitted to the cabinet side (adjacent to the Command

Centre air inlet) as shown below. It must take in air from the room or another ventilated space.

This space could be an adjacent cupboard, (via a communicating port) on condition that it does not contain a heat generating appliance. The vent grille or the angled inlet grille supplied should be fitted in the adjacent cupboard, observing 100mm separation from the vent tray exhaust.

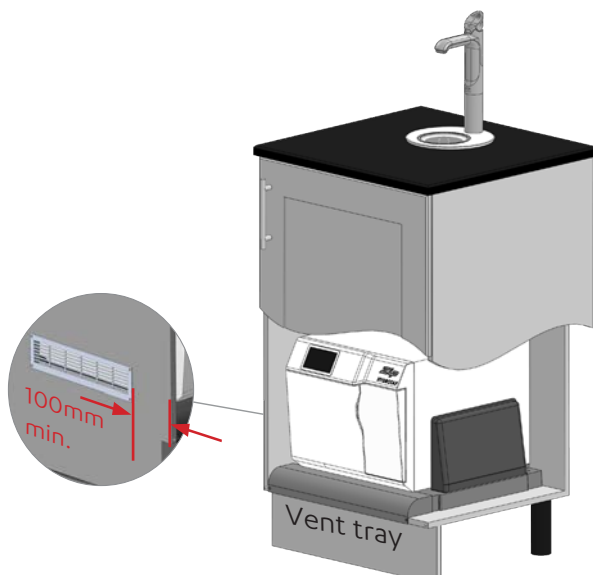



### 1.3 BC, BCS Commercial compact Command Centres

#### 1.3.1 Ventilation for all models

- The clearance envelope dimensions stated in the specification sheets and installation instructions must be observed.
- Adequate ventilation must be provided to ensure that the cupboard space temperature does not exceed 35°C.

#### 1.3.2 Preferred arrangement

- The vent kit supplied with the Command Centre should be used to provide adequate ventilation by convection in normal usage.

**Note** The vent kit has to be installed in a way that allows air to be drawn in from the bottom of the cupboard and expelled through the top of the cupboard. The outlet vent **A** should be towards the top of the door (position **A2**) or side of the cupboard (position **A1**). (Where possible air inlet vent and the air outlet vent should be positioned at opposite ends of the same cupboard space).

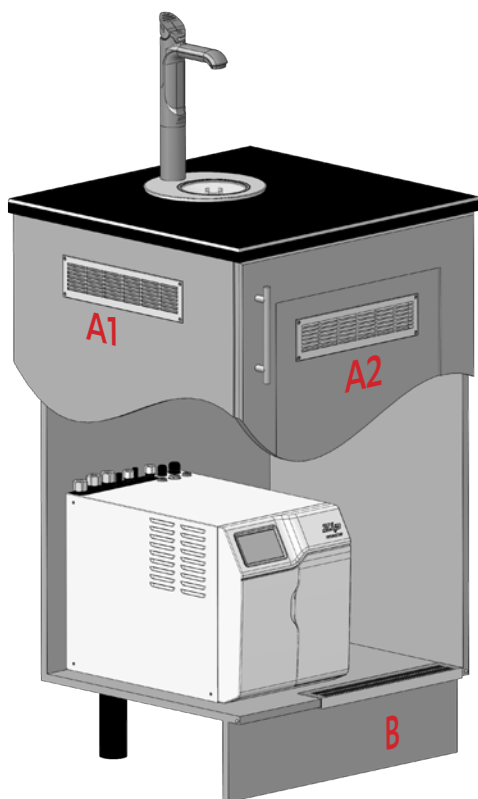

#### 1.3.3 Alternative arrangement

In situations where the preferred arrangement does not provide adequate ventilation by natural convection a Dual exhaust fan kit\* (SP93156) must be fitted to the cupboard door or side (as shown in the illustration below) and connected to the Command Centre DIN socket.

\* For dual exhaust fan cut-out dimensions see the instructions provided with the kit.

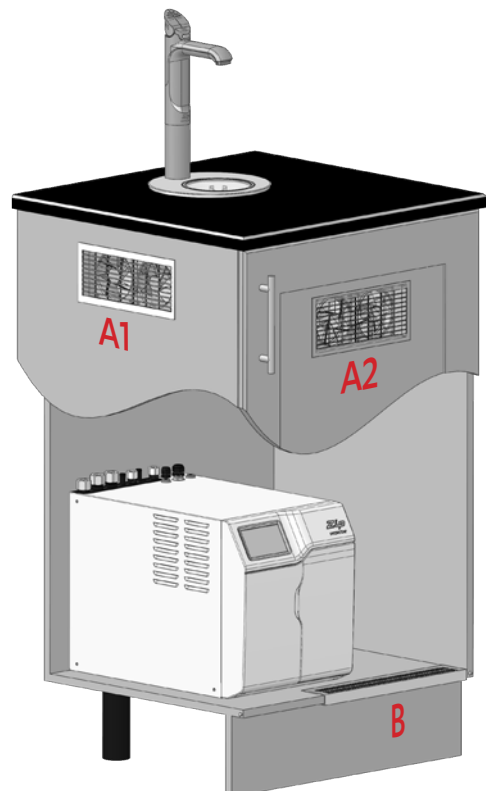

Vent cut-out details

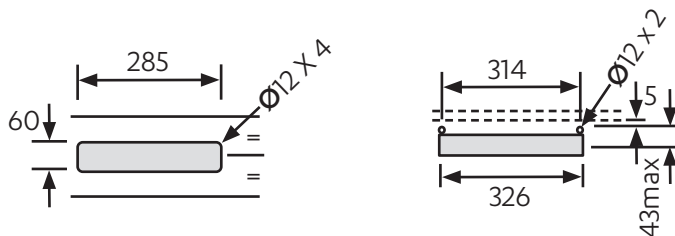

\*A Air outlet vent

B Air inlet vent

**Note** Flat outlet vent detail shown above, louvred outlet vent also supplied.

## 1.4 BO & BA Commercial, BO Residential Command Centres

### 1.4.1 Ventilation for all models

- The clearance envelope dimensions stated in the specification sheets and installation instructions must be observed.
- Adequate ventilation must be provided to ensure that the cupboard space temperature does not exceed 35°C.

### 1.4.2 Preferred arrangement

- 4mm door buffers (at the four corners of each door) supplied with the Command Centre should be used to provide adequate ventilation in normal usage, see illustration below.

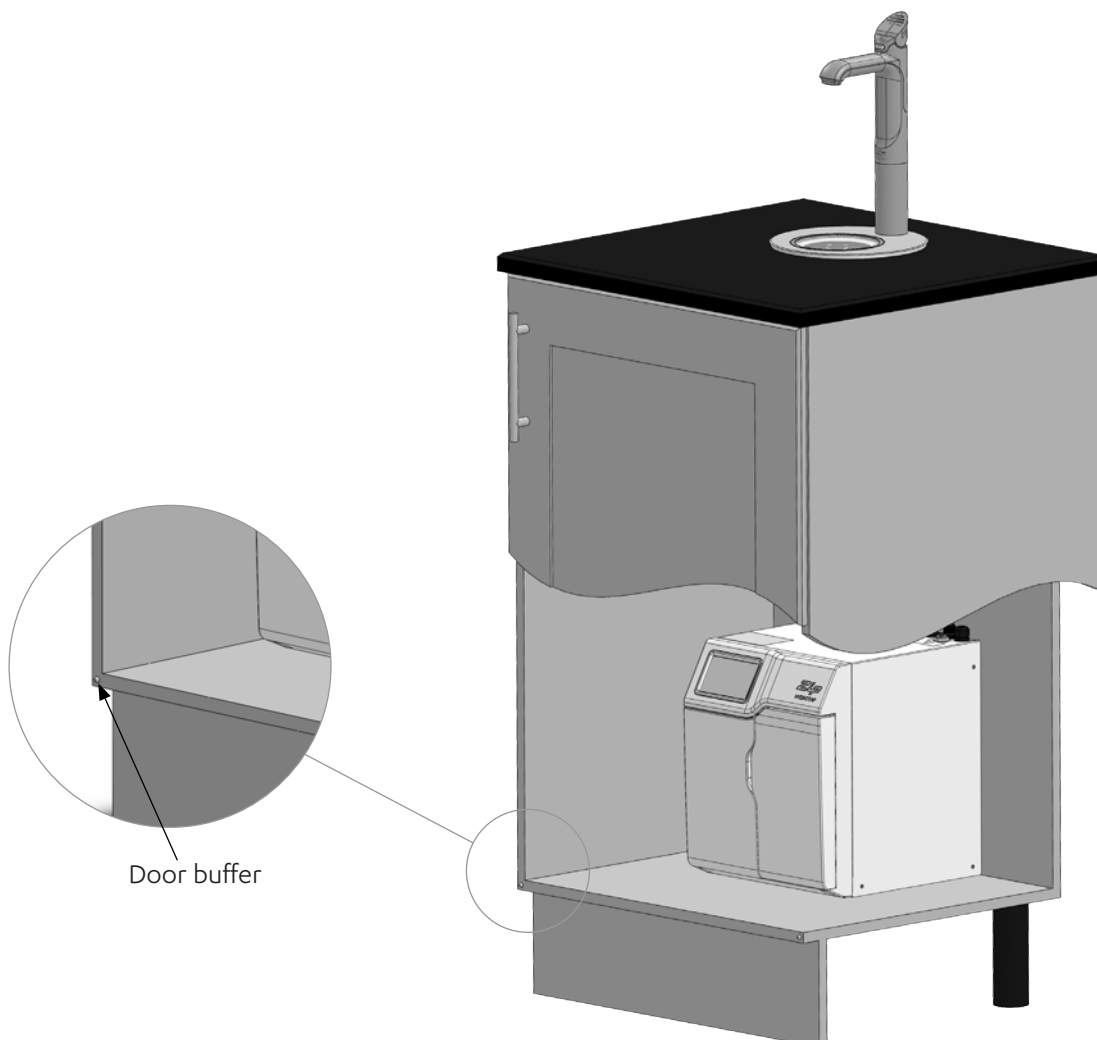

## 1.5 CS & C Commercial Command Centres

### 1.5.1 Ventilation for all models

- The clearance envelope dimensions stated in the specification sheets and installation instructions must be observed.
- Adequate ventilation must be provided to ensure that the cupboard space temperature does not exceed 35°C.

### 1.5.2 Preferred ventilation arrangements for CS models

The ducted vent kit supplied with the Command Centre exhausting through the kick-space should be used, to provide adequate ventilation in all conditions. (Ancillary components are not shown in these diagrams).

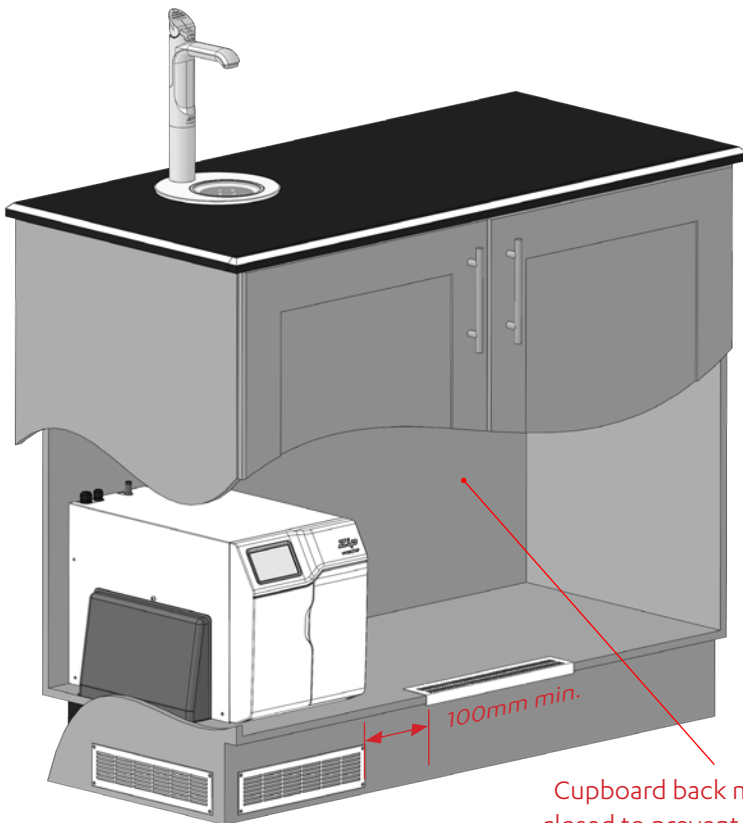

#### Vent cut-out details

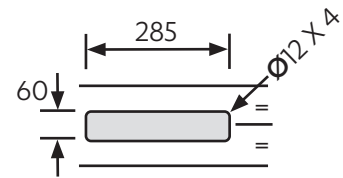

**A Air outlet vent**  
(flat vent)

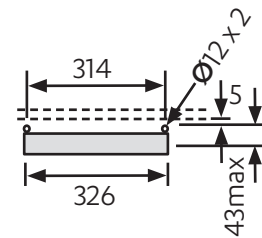

**B Air inlet vent**

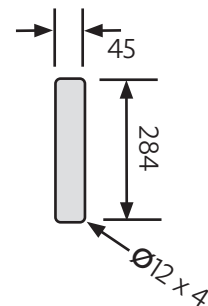

**C Ducted vent**

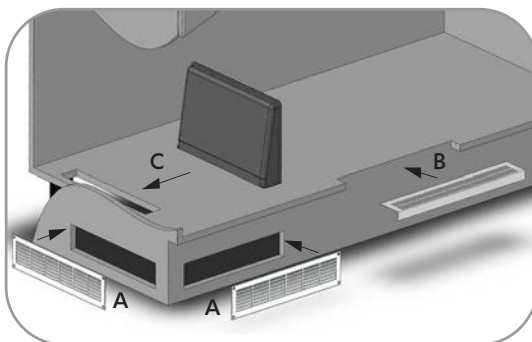

### 1.5.3 Alternative arrangement (Dual fan kit)

In situations where the preferred arrangement cannot be used or will not work effectively e.g.

- Single cupboard where the 100mm grille spacing cannot be achieved.
- Where there are openings in the back of the cupboard allowing exhaust air to recirculate into the cupboard space.

An SP93156 Dual exhaust fan kit\* must be fitted in either arrangement A or B shown below and connected to the DIN socket on the Command Centre .

**A** Fan kit fitted to kick board and with kick space duct fitted to the Command Centre.

**B** Fan kit fitted to cupboard door (position B1) or side (position B2) and without kick space duct fitted to the Command Centre.

\*For dual exhaust fan cut-out dimensions see the instructions provided with the kit.

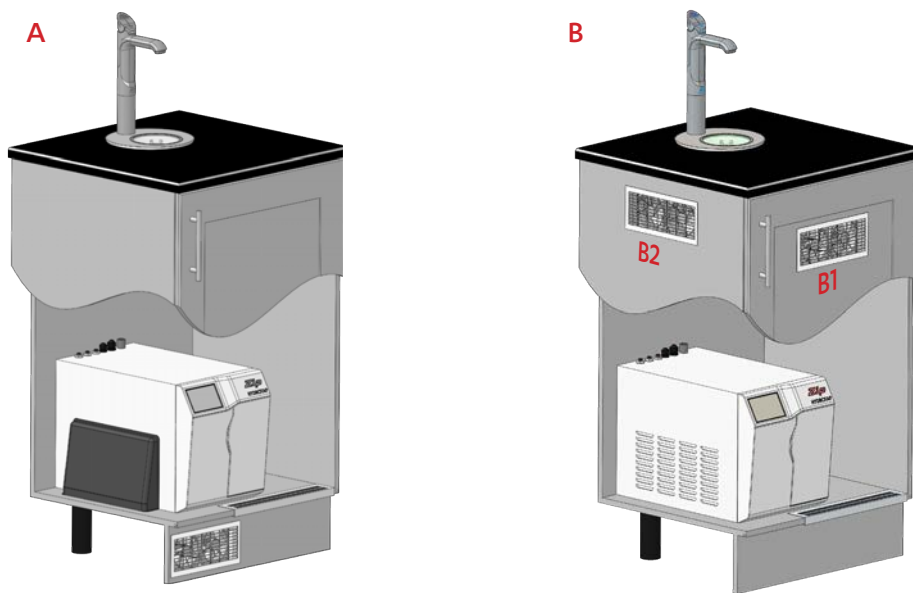

### 1.5.4 Alternative arrangement (Vent tray)

In situations where cupboard width is 1000mm or greater, without central pillar and where vent grilles cannot be fitted in the kick board (e.g. hospitals) use a **Vent tray kit** (CS SP93541).

A vent grille, supplied should be used as an inlet vent and fitted to the cabinet side (adjacent to the Command Centre air inlet) as shown below. It must take in air from the room or another ventilated space. This space could be an adjacent cupboard, (via a communicating port) on condition that it does not contain a heat generating appliance. The vent grille or the angled inlet grille supplied should be fitted in the adjacent cupboard, observing 100mm separation from the vent tray exhaust.

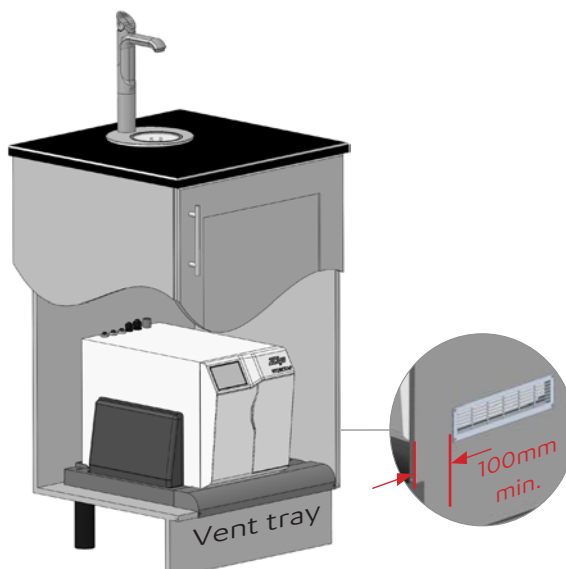

## 1.6 BC, BCS, Residential Command Centres

### 1.6.1 Ventilation for all models

- The clearance envelope dimensions stated in the specification sheets and installation instructions must be observed.
- Adequate ventilation must be provided to ensure that the cupboard space temperature does not exceed 35°C.

### 1.6.2 Preferred arrangements

4mm door buffers (at the four corners of each door) supplied with the Command Centre should be used to provide adequate ventilation in normal usage, see illustration below.

### 1.6.3 Alternative arrangement

- For high use applications where the cupboard space temperature is near 35°C or higher, the vent kit supplied can be used to provide further ventilation by convection.

**Note** The vent kit has to be installed in a way that allows air to be drawn in from the bottom of the cupboard and expelled through the top of the cupboard. The outlet vent should be towards the top of the door (position A1) or side of the cupboard (position A2). (Where possible air inlet vent and the air outlet vent should be positioned at opposite ends of the same cupboard space).



Door buffer

**Note** Flat outlet vent detail shown, louvred outlet vent also supplied.

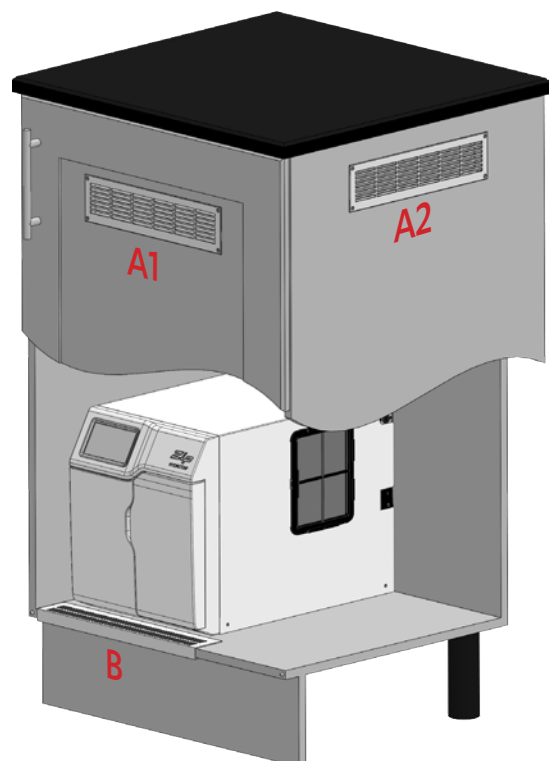
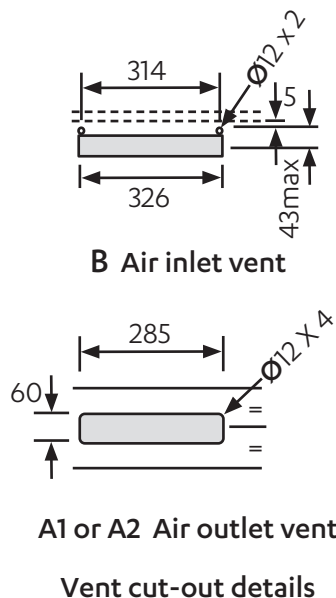

## Section 2 Booster system

### 2.1 Product description

The booster system is a compact electronically controlled auxiliary water heater. It is intended to provide pre-heating of water before it enters the Zip HydroTap G4 boiling tank. If the booster is used the boiling water output will be increased.



**Note 1** Water connection blue cap - water in  
red cap - water out.  
The braided hoses cannot be lengthened.

**Note 2** The electrical cable length is 0.6m.

**Note 3** Position the booster within reach of the fixed hose lengths, keeping the booster as close as possible to the Command Centre inlet / outlet connections.

**Note 4** Ensure the booster is mounted in an upright position (as shown) with a horizontal base.

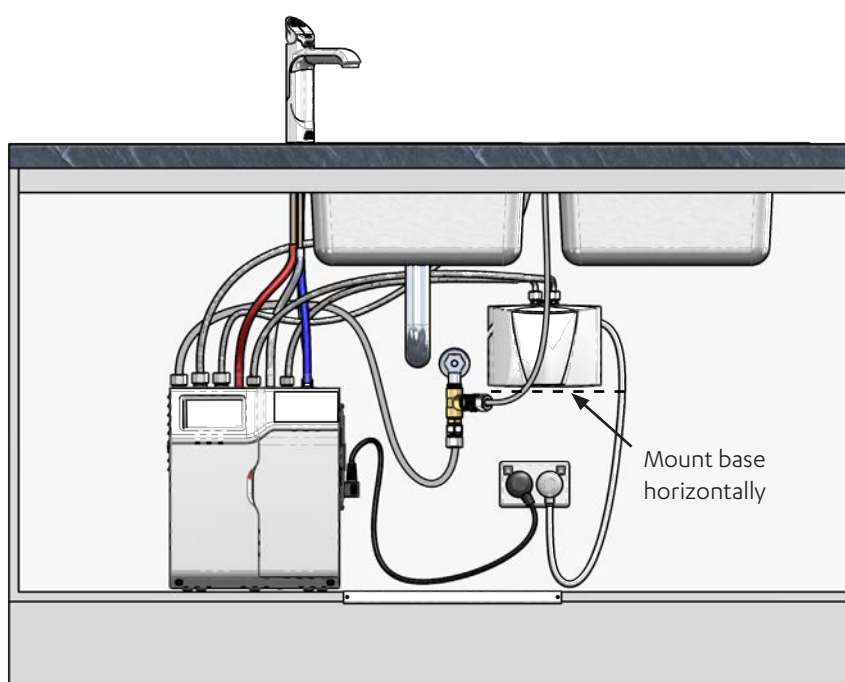

**Note 5** Before you install a booster, determine whether an external water filter / softener is required. If an external water filter / softener is required, the external bypass valve must be set correctly, see page 32.

### Booster specifications

	Rating	Unit
Nominal power rating	2.2	kW
Nominal current	10	A
Electricity supply 50Hz AC	230	V
Electrical flex, white - 0.6m nom. length	13	A
Fixed flow rate	1.2	L/min

## 2.2 Installation procedure

### Site requirements

- Booster must only be installed in a frost-free area. Never expose booster to frost.
- The booster is designed for wall mounted installation and must be installed with water connectors facing upwards.
- The booster is protected against water ingress to class IP 25.
- The 500mm braided hoses supplied with the booster cannot be lengthened.
- The 90° elbow hose ends should be fitted to the inlet and outlet connections on top of the booster.
- The hot water outlet hose must be thermally insulated with the insulation provided.

### 2.3 Booster installation see diagrams below

- To remove the mounting chassis, insert a flat blade screwdriver all the way into the lock.
- Gently angle the screwdriver upwards by approximately 10°.
- Pull the booster forwards by approximately 15°.
- Carefully pull the booster upwards to complete the removal process. Take care not to break the lower clips.
- Attach the mounting chassis horizontally to the wall / cupboard wall.
- To install, clip the booster into the on the mounting chassis and snap into position (see installation below).

**Note** Remove the wall mounting chassis from the rear of the booster for wall mounting.

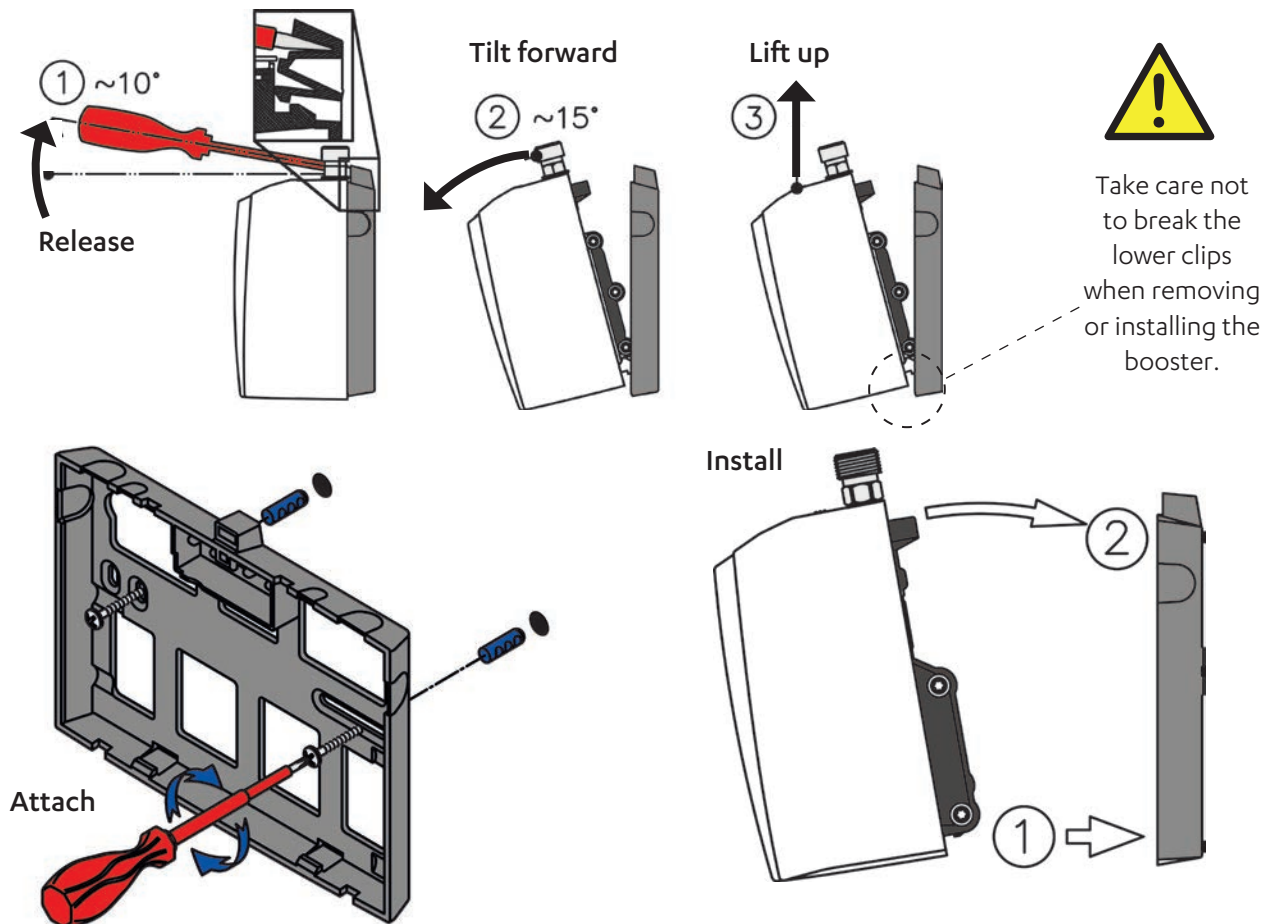

**Note 1** The booster is intended for use with the Zip HydroTap G4 Command Centre

**Note 2** Water connections must be pointing vertically upwards.

**Note 3** The booster unit should be installed as close as possible to the Zip HydroTap G4 as the 500mm connection hoses cannot be lengthened.

### 2.4 Braided hose connections

- The cold water inlet (blue cap) and hot water outlet (red cap) are marked on the rating plate. Connect the braided hoses from the 'BYPASS OUT' fitting on the Command Centre to the water inlet of the booster (blue cap) and from the outlet of the booster (red cap) to the 'BYPASS IN' fitting on the Command Centre. Avoid exerting mechanical force on the booster. This can be achieved by using a spanner on the flats of the inlet and outlet connections when tightening the braided hose connectors. Do not over-tighten ! Tighten the braided hoses by hand, then turn a further 90° to 180° with a spanner.
- Once the water connections have been made, check for any leaks and rectify as necessary.

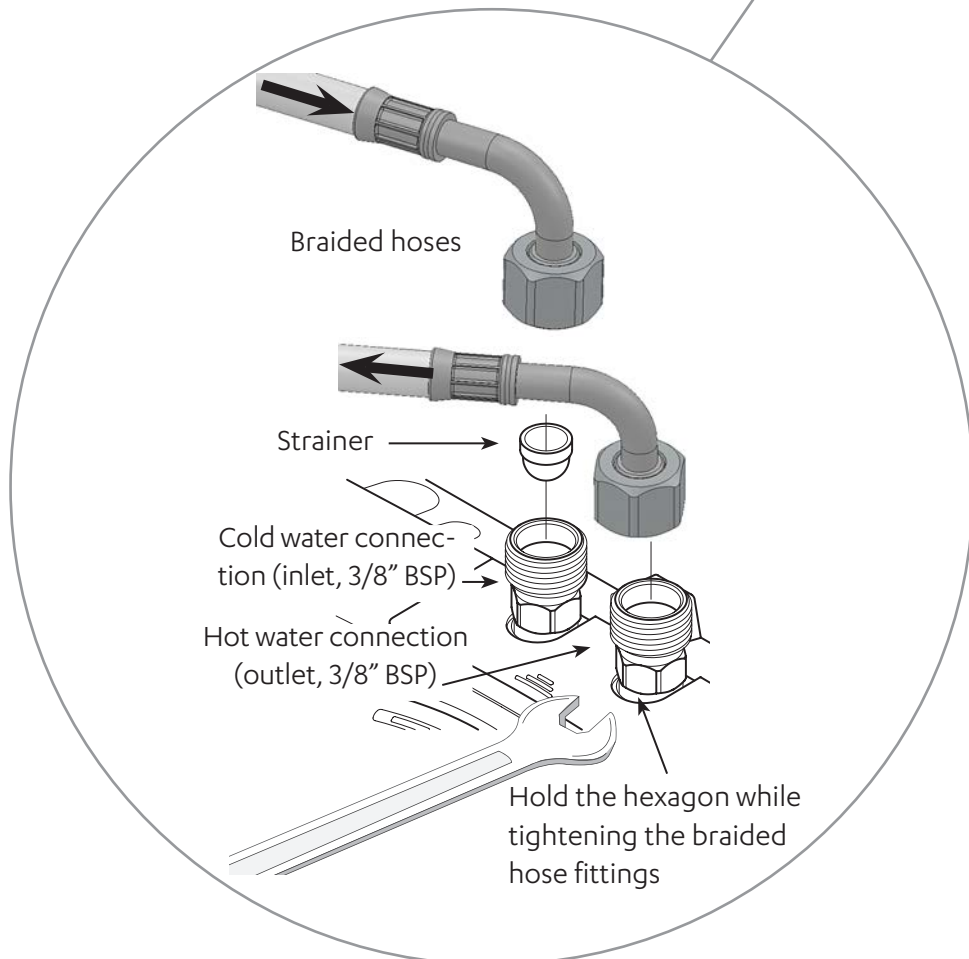
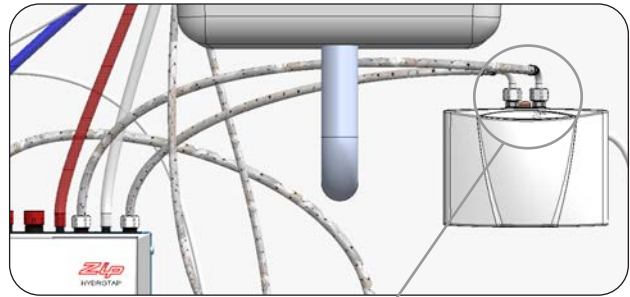



## Section 3 Filter / softener installation

An external filter / softener may be fitted to reduce the incidence of scale build up in the hot tank or may be supplied at the customer's request.

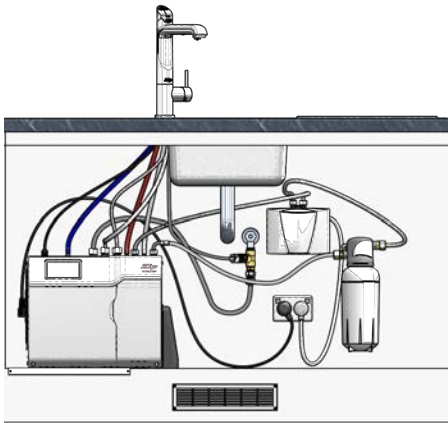

### 3.1 Mounting the filter head

- All information required to mount the filter head is available separately in the following document :
- Zip scale filter head installation and operating instructions 2017, supplied with the filter head.

### 3.2 Cartridge installation and flush

- All information required to install and flush the cartridge is available separately in the following documents:
- Zip scale filter cartridge installation and operating instructions 2017, supplied with the filter cartridge.
- Zip scale filter head installation and operating instructions 2017, supplied with the filter head.

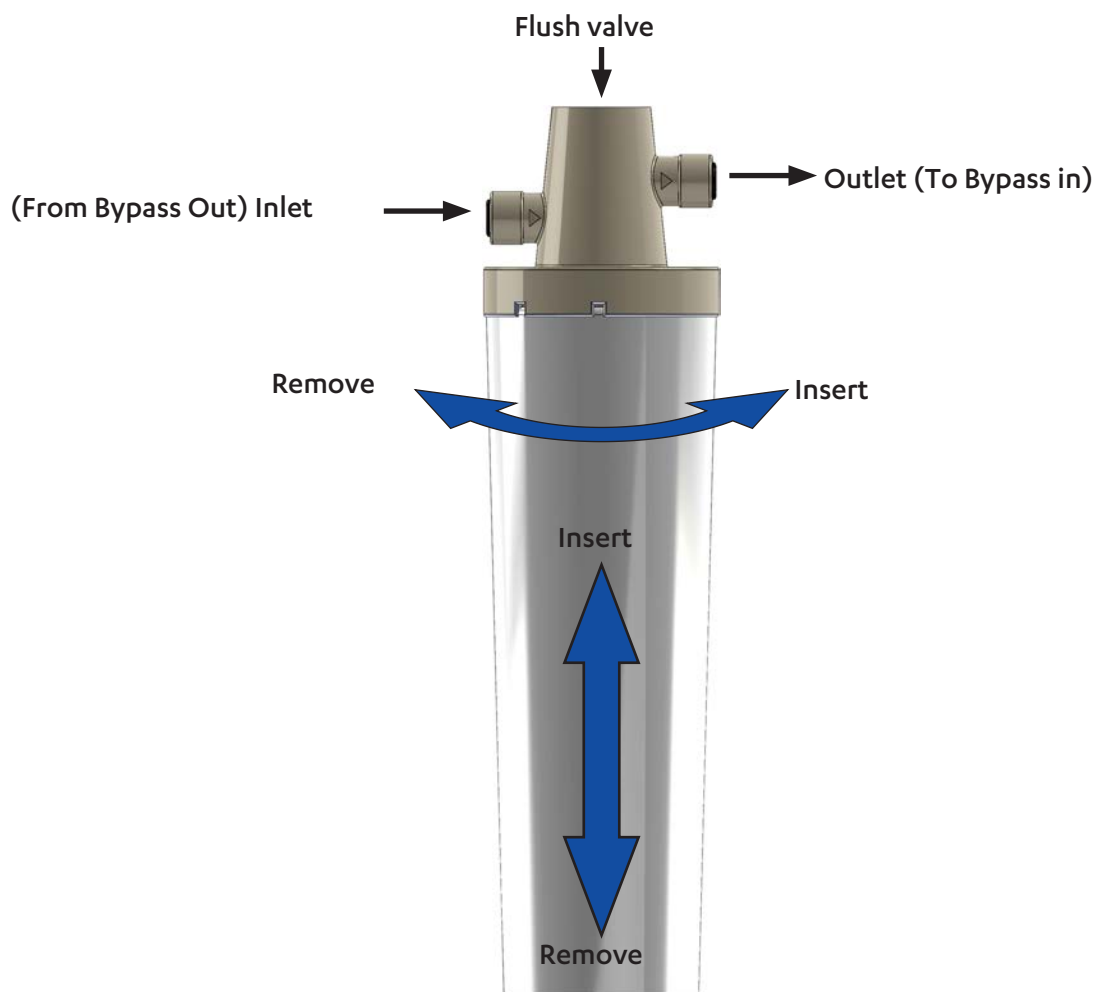

## Section 4

# CO<sub>2</sub> Cylinder installation



### STORAGE WARNING

The cylinder contains 1.2kg of CO<sub>2</sub> and should be installed in a well ventilated area.

You can have serious health problems if breathing air containing concentrations of CO<sub>2</sub> up to 15000ppm (1.5%) for more than 10 minutes. Proper ventilation must be provided to ensure that, in case of escape, concentrations of CO<sub>2</sub> remain below this level.

See gas cylinder and MSDS sheet for complete list of warnings.

### 4.1 Secure the cylinder

Secure the gas cylinder supplied to a suitable wall, within 1 metre of the Command Centre, in an upright position. This is undertaken by screwing the metal bar holding the hook-and-loop strap to a cupboard wall, 200mm above the floor or base of the cupboard. Make sure the gas cylinder can stand in place before securing to the wall. Due to regulatory requirements the gas cylinder must be stored securely and in an upright position.

### 4.2 Connect the regulator

Remove the gas cylinder from the strap. Make sure the regulator knob is turned fully clockwise to the end-stop before fitting. Screw the regulator (clockwise) onto the cylinder. Be aware that some CO<sub>2</sub> may be discharged from the connection between the cylinder and the regulator when assembled together. Any CO<sub>2</sub> released will be cold. Screw on the regulator to stop this leakage.

Turn the knob fully clockwise before fitting the regulator

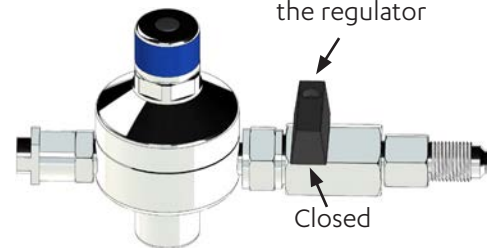

**Note** The leaking CO<sub>2</sub> will be cold.

### 4.3 Connect the gas hose

Connect the threaded end of the braided gas hose to the regulator. Then connect the push fit fitting to the top of the Command Centre via connection marked 'CO<sub>2</sub> IN'.

To turn the gas on, rotate the regulator knob anti-clockwise to the end stop.

### 4.4 Test for gas leaks

Using soapy water perform a leak test. Apply the soapy water to the gas connections using a sponge or brush. If any bubbles appear and grow, there is a gas leak at the connection. Clean away the soapy residue and tighten or refit the leaking connection. Make sure the gas is turned off when tightening or refitting the leaking connection.

Refit the gas cylinder to the hook-and-loop strap. Ensure the cylinder is in an upright position.

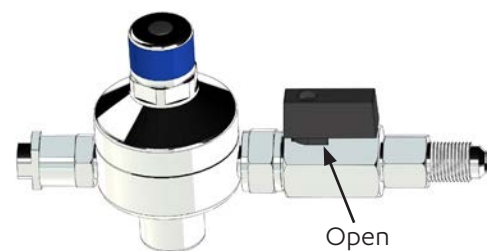

## CO<sub>2</sub> Regulator

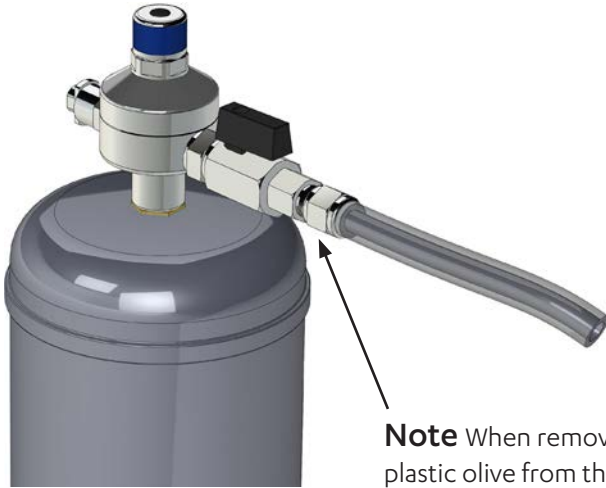

**Note** When removing hose, take care not to lose plastic olive from the fitting.

## Leak test



**After replacing a cylinder or after making a gas connection, perform a leak test** to check for gas leaks between regulator and cylinder, and between regulator and braided hose.

### Stage 1

- Turn the gas off.
- Using soapy water applied with a sponge, or with a brush, cover all of the gas joints with a liberal amount of suds.

### Stage 2

- Turn the gas on.
- Inspect the joints for leaks.
- If any bubbles appear to grow, the joint will need to be resealed and tested again.



Test for leaks at these two points

## Section 5 Water block installation

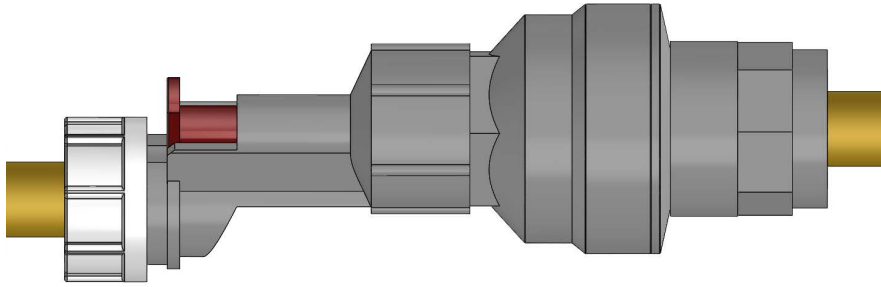

### 5.1 Description

- The Water Block is designed to be installed upstream of any Zip product and associated pipe-work to minimise the potential for water leakage in the event of a system malfunction.
- The Water Block is ideal for limiting potential leakage and resulting water damage from water heaters, water chillers etc. when fitted in supply pipe work that is subject to mains water pressure.
- Once set, the Water Block will ensure that the volume of water that can flow through at one time is limited to a pre-determined maximum, providing the flow rate through it exceeds 2 litres per minute.
- The Water Block also incorporates a non-return valve.
- The Water Block is WRAS approved.

### 5.2 Specification

Flow control range	5 - 50 litres
Minimum / Maximum pressure	0.2 - 10.0 bar
Maximum ambient temperature	40°C
Maximum water temperature	70°C
Minimum operating flow rate	1.5 +/- 0.5 litres / min.
Inlet connection	¾" BSP female or 15mm
Outlet connection	¾" BSP male or 15mm



### 5.3 Precautions

- The Water Block will help to contain leakage exceeding a rate of 2 l/min.
- **Note** The leakage at lower flow rates may not be detected by the Water Block and could remain unchecked.
- Appropriate measures should be taken to contain leakage in these circumstances.

## 5.4 Installation



**Note.** This device must be installed vertically with the direction of flow downwards (inlet at the top , outlet at the bottom. See Fig 1 adjacent).

- The Water Block should be installed in a convenient location on the water supply line to the Zip product.
- Pointer 'P' (see Fig.3) should be rotated until in line with the maximum required flow at one time. Each number on the scale corresponds to 5 litres of flow i.e. 1 = 5 litres, 10 = 50 litres.
- The adjustment key (see Fig.2) should be used to adjust the pointer.
- The inlet should be connected via an 15mm isolation valve (not supplied).
- The outlet shall be connected via the 15mm - 1/2" brass compression fitting supplied.
- Ensure that the direction of flow through the Water Block is correct and that the filter screen (see Fig.2) is inserted correctly with the convex surface facing towards the water supply.

Fig.1

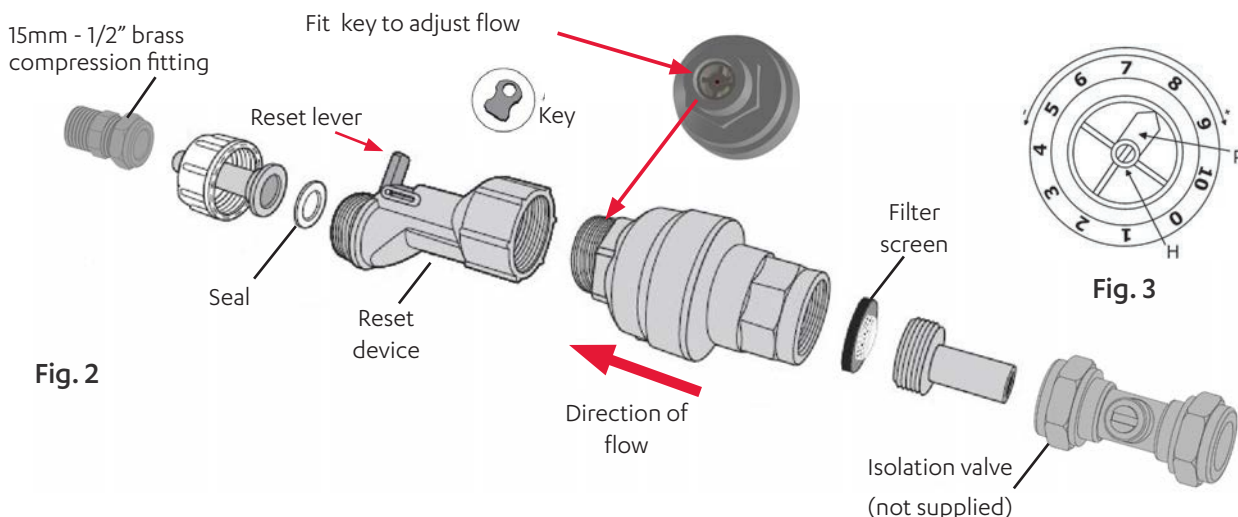
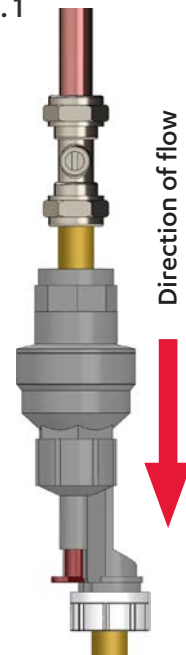

Fig. 2

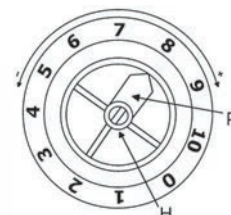

Fig. 3

## 5.5 Reset Procedure

- The Water Block will activate and shut off the supply if more water than the set amount is drawn off at one time.
- In this event firstly isolate and de-pressurise the water supply to the Water Block, identify and repair the cause of the leak then remove the pipe-work downstream of the Water Block and press the reset button 'H' (see Fig.3).
- The reset device (see Fig.2) may be fitted to avoid disconnection. This allows the Water Block to be reset by operating the lever in the direction shown in Fig.2.
- In the event of persistent tripping contact Zip for advice on 0345 6 005 005.

## 5.6 Maintenance

- The filter screen should be checked and cleaned periodically subject to water conditions and usage.

## Section 6 Carbonation valve installation

- Fitted in sparkling systems only

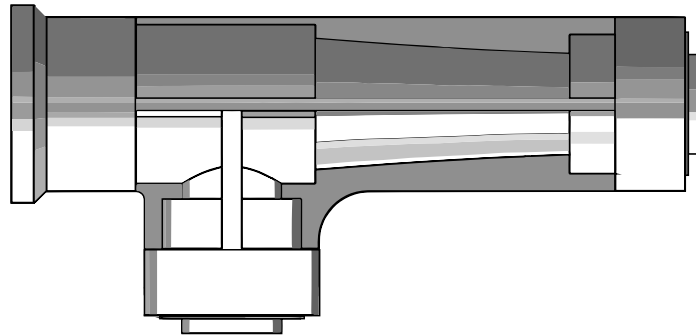

### 6.1 Description

The carbonation valve has been designed to provide the installer with the ability to preset the level of carbonation of the sparkling water, to the taste of the user. The carbonation valve can be fitted at the time of installation, or retrofitted to G4 Command Centres previously installed.

### 6.2 Installation

- Attach the carbonation valve to the Command Centre using the 1/4" plastic tubing.
- Attach the sparkling pipe to the outlet .

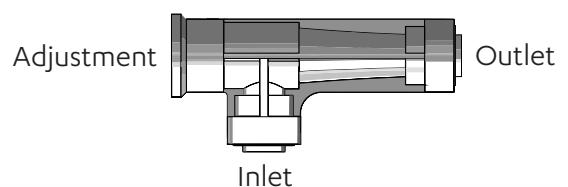

### 6.3 Adjustment

The carbonation valve has an adjustable flow rate. The optimum setting for the valve is 1.6 litres/minute. Use a 6mm Allen key or large flat blade screwdriver to adjust the flow rate of the valve.

To adjust the flow rate rotate the screw anti clockwise. Fitting this valve should reduce the splatter or spitting of the sparkling water out of the tap. It should also produce more visible bubbles in the water. To measure the flow rate, use a measuring cup and run the sparkling water for 15 seconds. Multiply the amount of water dispensed by 4 to get the flow rate per minute. 1.6litres/min. is the optimum flow rate.



If the flow rate is adjusted too high, the carbonation can will be emptied of water, leaving only CO<sub>2</sub> to be dispensed from the tap.

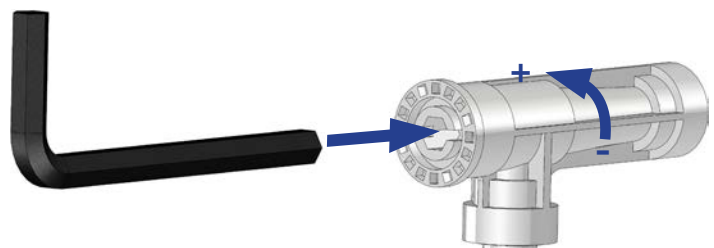

## Section 7

# Command Centre installation

### 7.1 Generic installation arrangement instructions



**Read these instructions before commencing Command Centre installation, they apply to all installation arrangements.**

- Read these instructions in conjunction with the following.
  - 803341 Tap installation instructions.
  - 210002 Scale filter head 2017 instructions (supplied with the scale filter head).
- Install the mains water braided hoses to the Command Centre before locating in place.
-  In the following diagrams the adjacent symbol denotes connections not required for specific HydroTap G4 models.
- Ambient mains water braided hose length is 750mm.
- Electrical power cable is 1.8m long.
- The Command Centre must be installed within the limits of the hose and cable lengths supplied.
- All silicon tubes / plastic pipes must be cut to size. They must have a constant fall back to the Command Centre.
- Isolation valves are not supplied.
- If the user requires mixed hot and cold water, as well drinking water from the G4 installation, but only has a cold mains water connection; Zip provide a range of 'special order' Command Centres which draw hot water from the Command Centre, the codes for both venturi & non venturi connections are referred to in this manual. See Technical data table page 12, for model numbers.

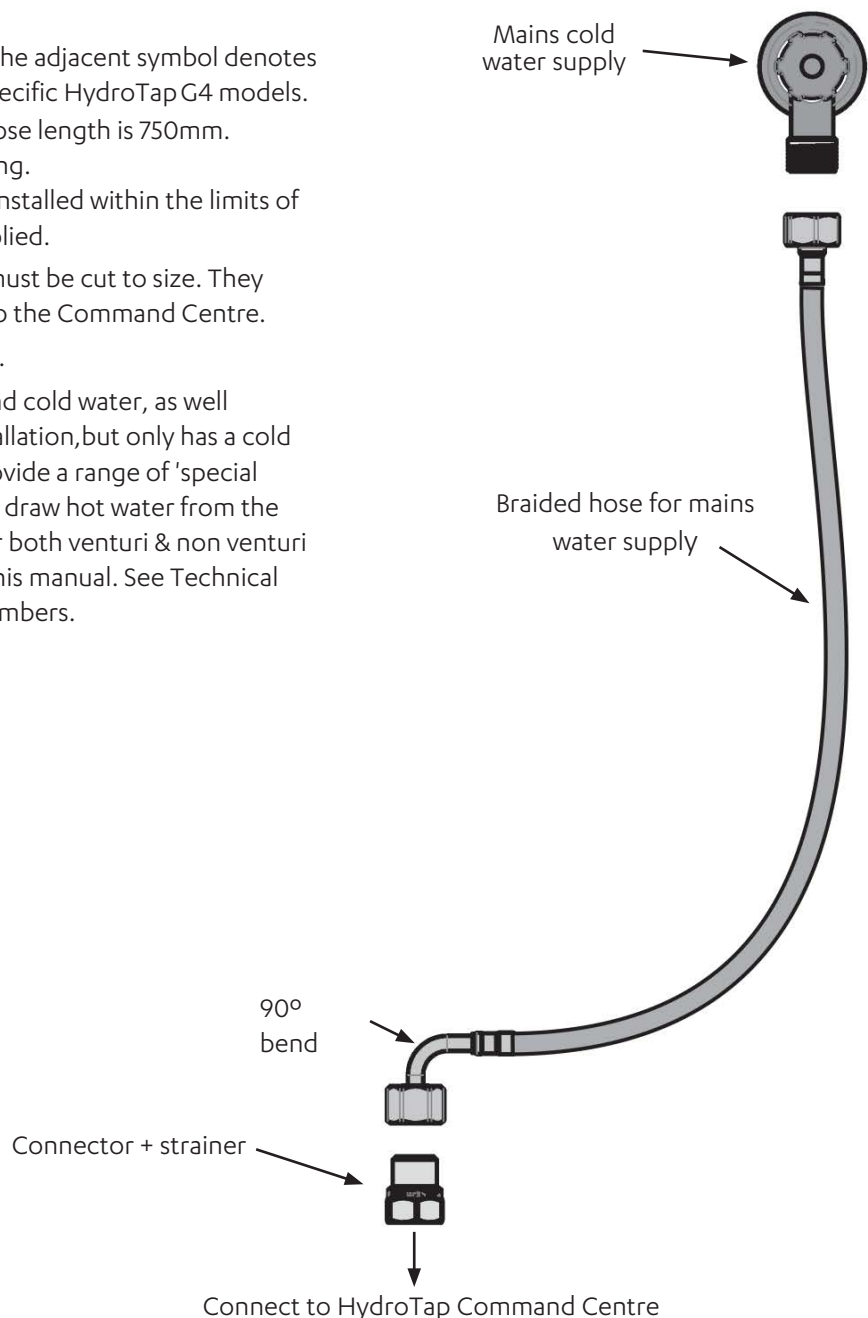

## 7.2 External bypass valve

### The following products have an external bypass valve

Boiling and Ambient  
 Boiling and Chilled  
 Boiling, Chilled and Sparkling

The external bypass valve allows the user to choose to have the boiling feed water bypass the internal filter and only be filtered by the external filtration. This valve is located at the rear panel of the Command Centre.

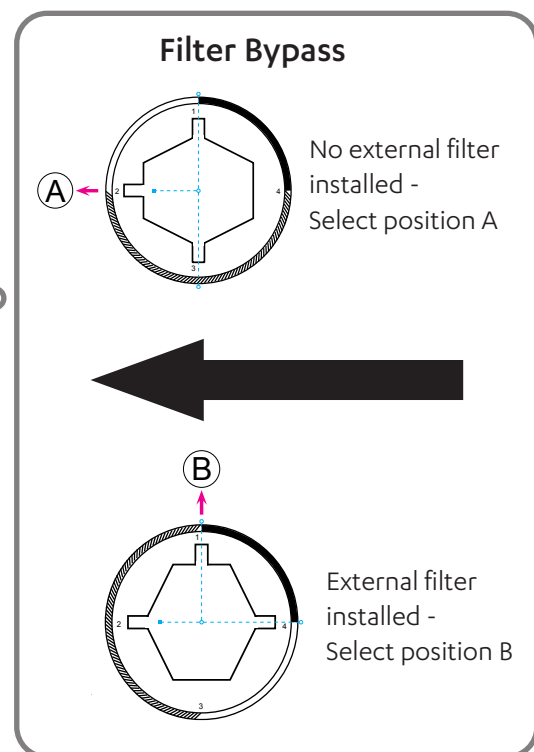
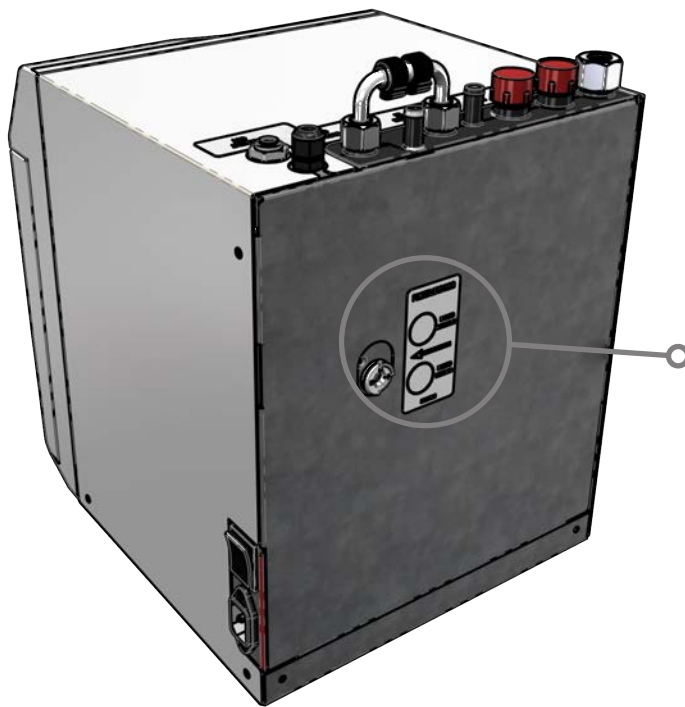



# Command Centre installation

## Table of contents

5253UK & 5053UK BCS Commercial	
7.3.1 HydroTap G4 models .....	35
7.3.2 HydroTap G4 and mixer tap combinations .....	36
7.3.3 All-in-One MAINS models .....	37
7.3.4 All-in-One VENTED models .....	38
2957UK, 2857UK, 1456UK & 1256UK BCS Commercial & residential compact	
7.4.1 HydroTap G4 models.....	40
7.4.2 HydroTap G4 and mixer tap combinations .....	41
7.4.3 All-in-One MAINS models.....	42
7.4.4 All-in-One VENTED models.....	43
5261UK & 5061UK BC Commercial	
7.5.1 HydroTap G4 models .....	45
7.5.2 HydroTap G4 and mixer tap combinations .....	46
7.5.3 All-in-One MAINS models .....	47
7.5.4 All-in-One VENTED models .....	48
2924UK, 2824UK,1414UK & 1214UK BC Commercial & residential compact	
7.6.1 HydroTap G4 models.....	50
7.6.2 HydroTap G4 and mixer tap combinations .....	51
7.6.3 All-in-One MAINS models .....	52
7.6.4 All-in-One VENTED models .....	53
5200UK, 5201UK, 5000UK, 5001UK, 1500UK, 1300UK, BO BA Commercial and BO residential.	
7.7.1 HydroTap G4 Boiling models .....	55
7.7.2 HydroTap G4 Boiling and Ambient models .....	56
7.7.3 HydroTap G4 Boiling and mixer tap combinations.....	57
7.7.4 HydroTap G4 Boiling and Ambient and mixer tap combinations.....	58
7.7.5 Celsius Boiling models .....	59
7.7.6 All-in-One Celsius Arc Boiling and Ambient models .....	60
0053UK CS Commercial	
7.8.1 HydroTap models .....	62
7.8.2 Celsius models.....	63
0061UK C Commercial	
7.9.1 HydroTap models .....	65
7.9.2 Celsius models.....	66

## 7.3 Command Centre installation 5253UK & 5053UK BCS Commercial

### Table of contents

7.3.1 HydroTap G4 models .....	35
7.3.2 HydroTap G4 and mixer tap combinations (5253UK only) .....	36
7.3.3 All-in-One MAINS models .....	37
7.3.4 All-in-One VENTED models (5253UK only) .....	38

### 7.3.1 HydroTap G4 models

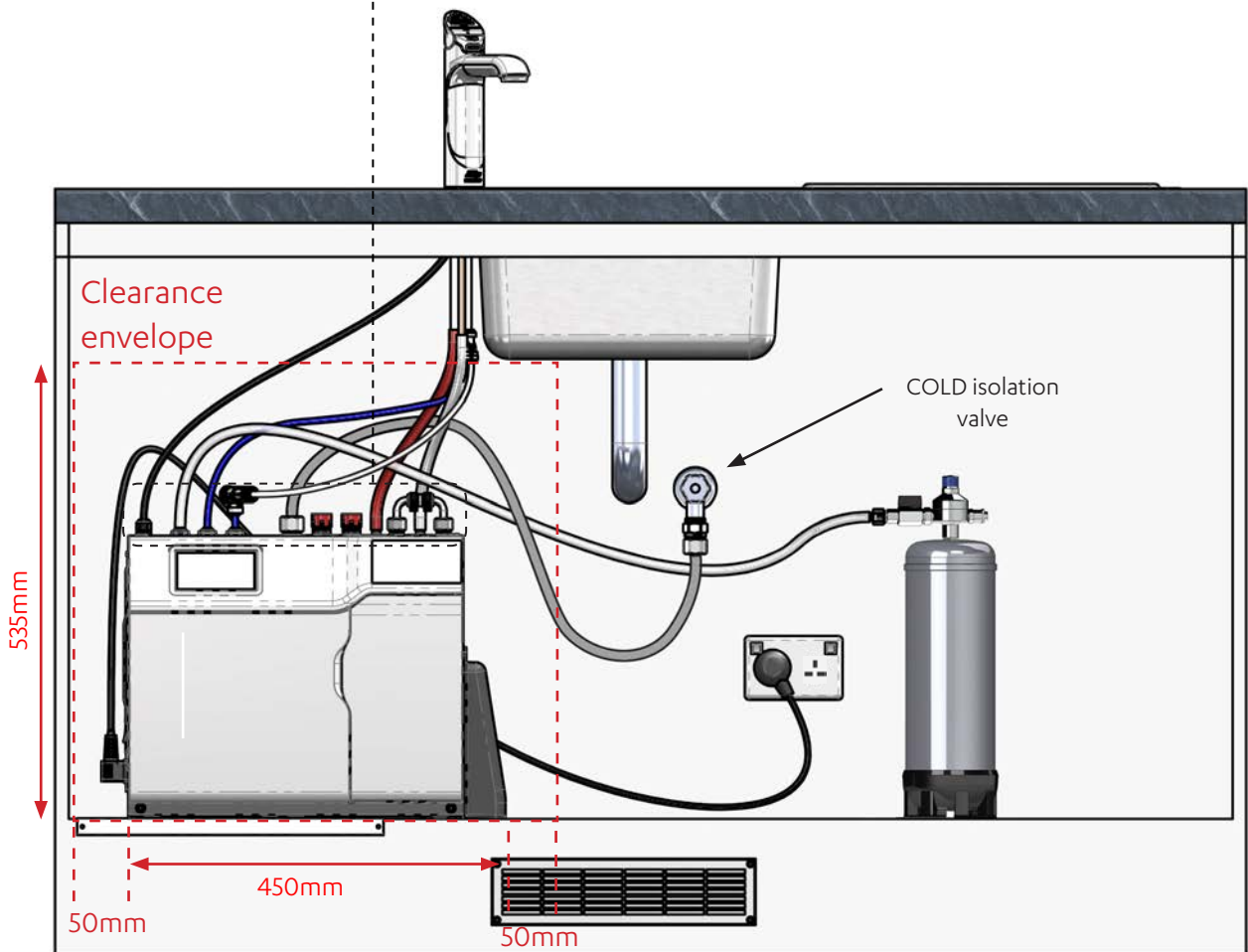
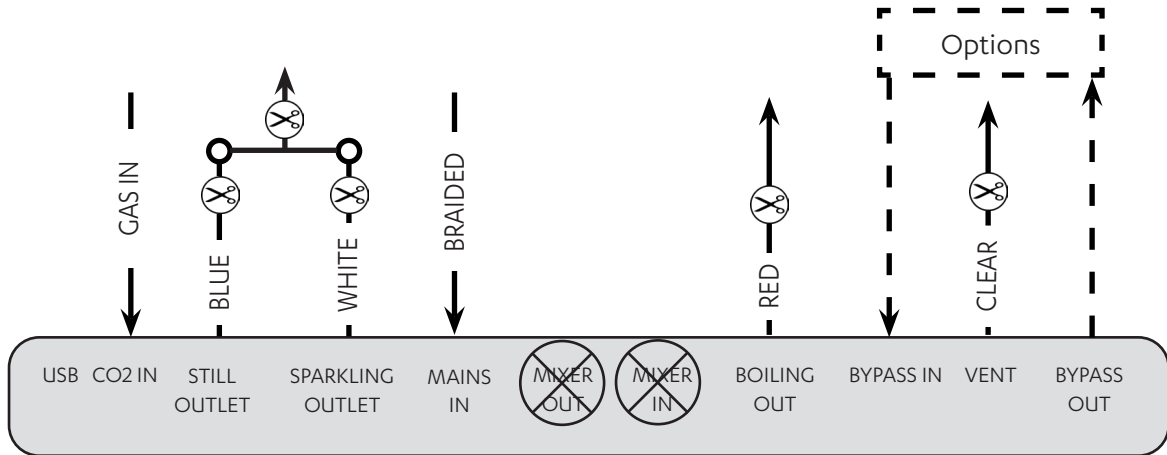

7.3.2 HydroTap G4 and mixer tap combinations

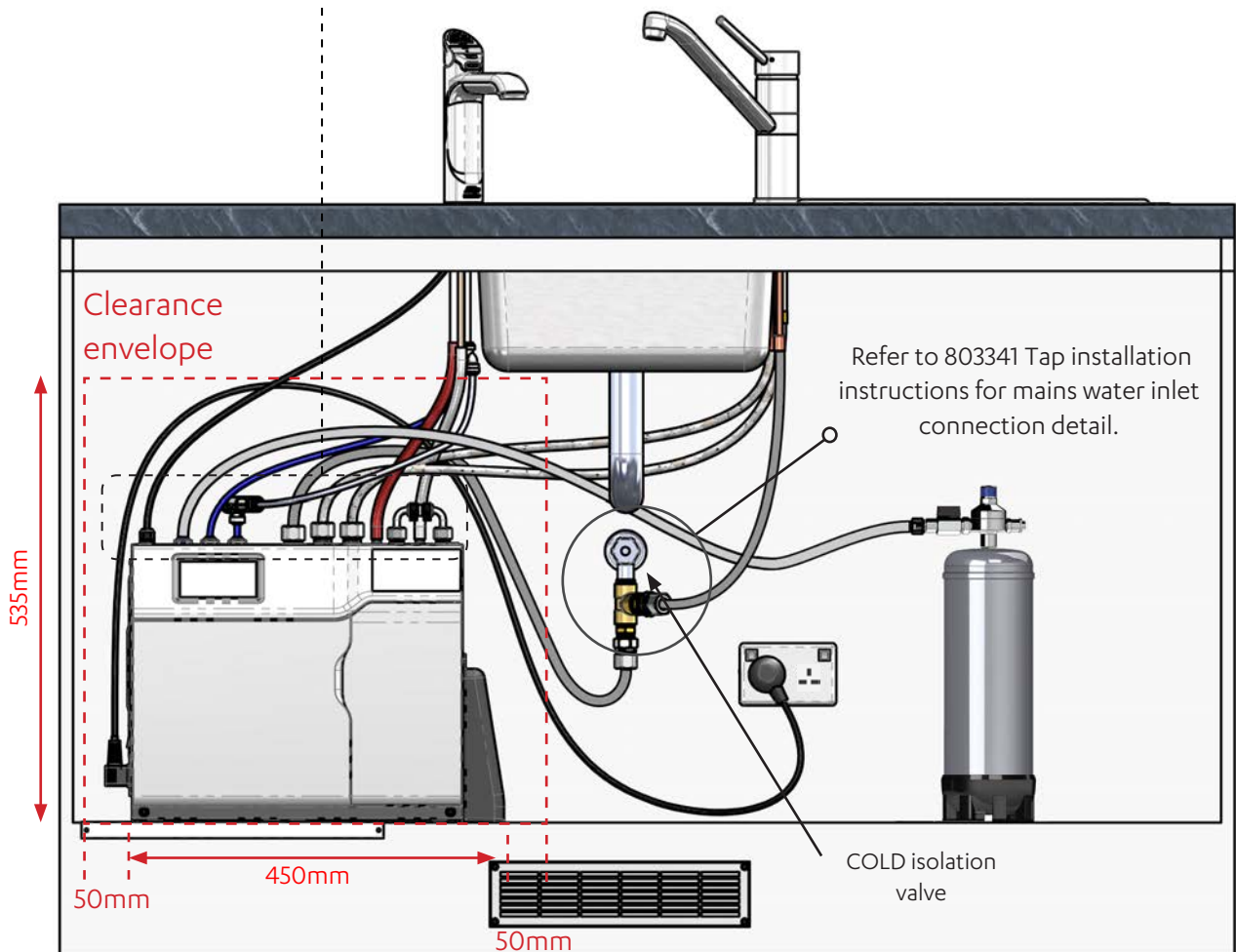
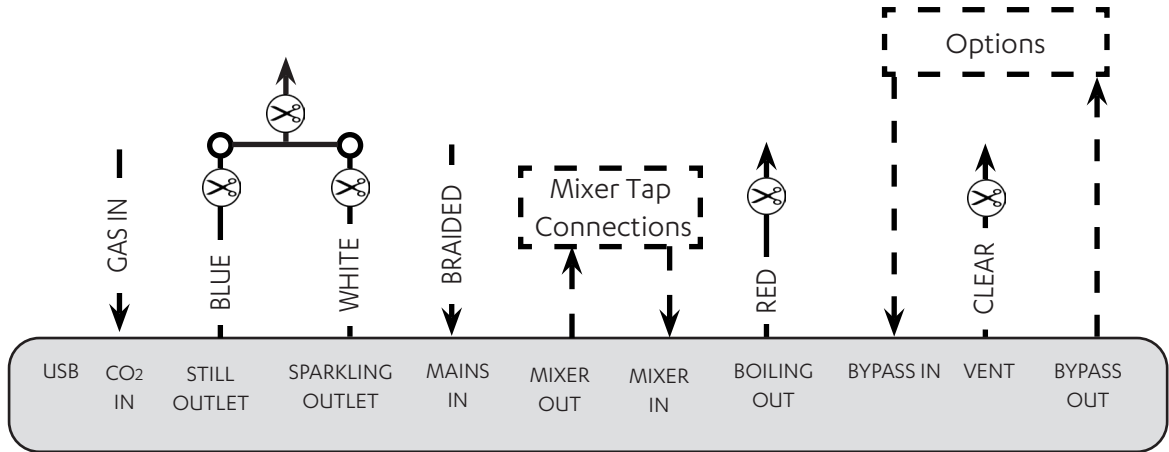
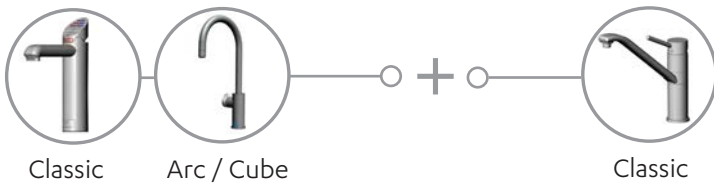

### 7.3.3 All-in-One 'Mains' tap

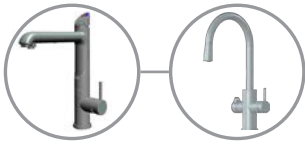

All-in-One Classic Mains

All-in-One Celsius Arc

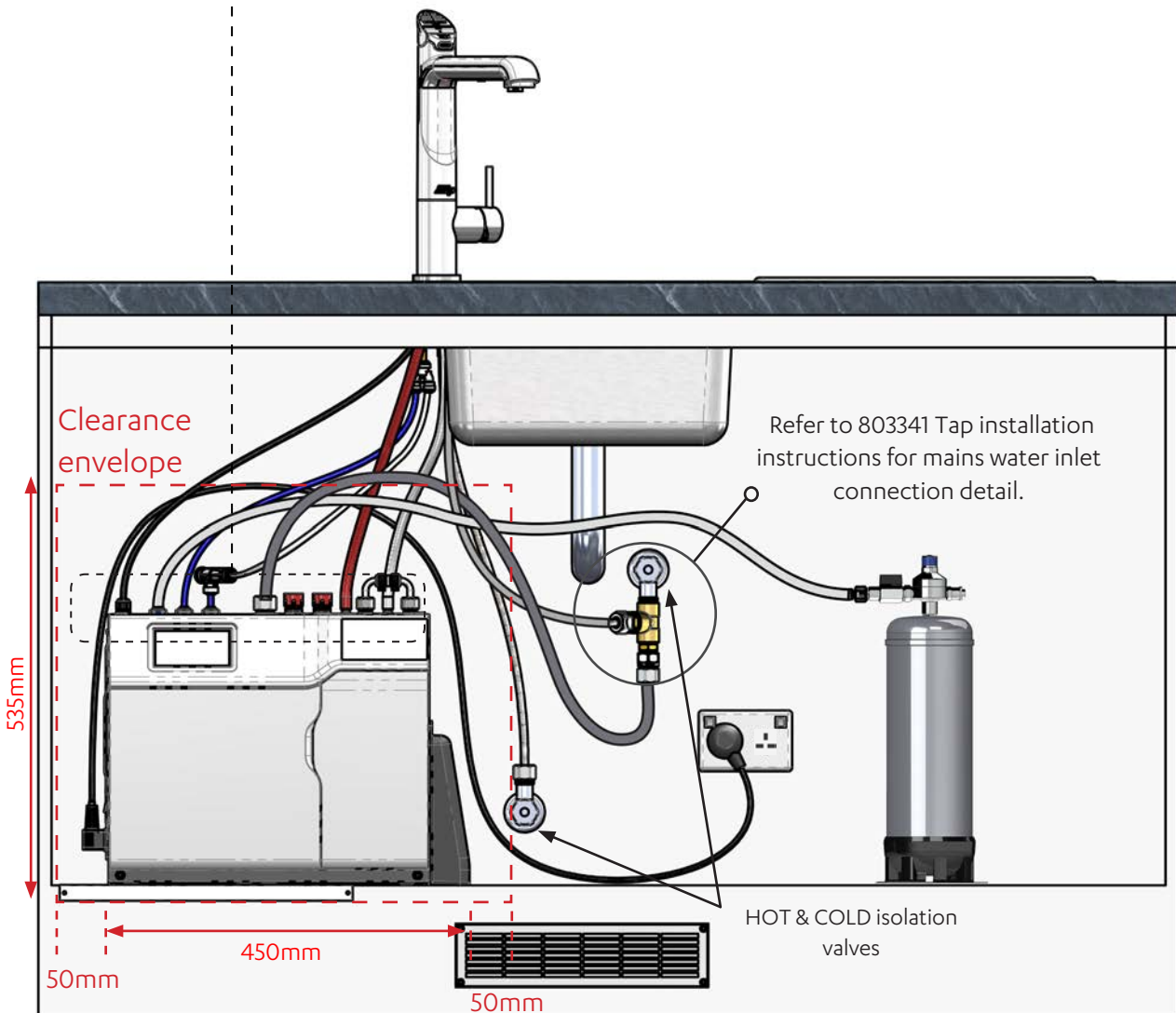
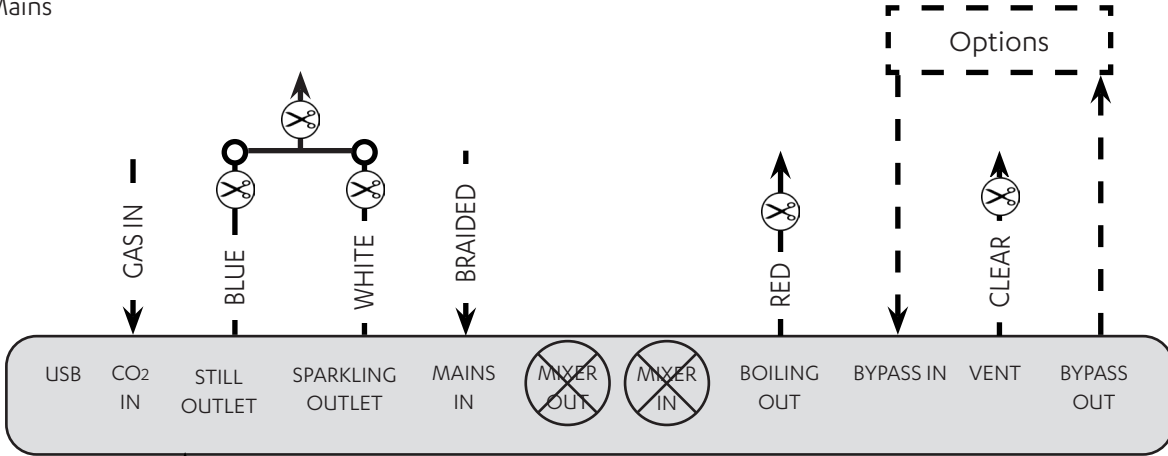

### 7.3.4 All-in-One Classic 'Vented' tap



All-in-One  
Classic  
Vented

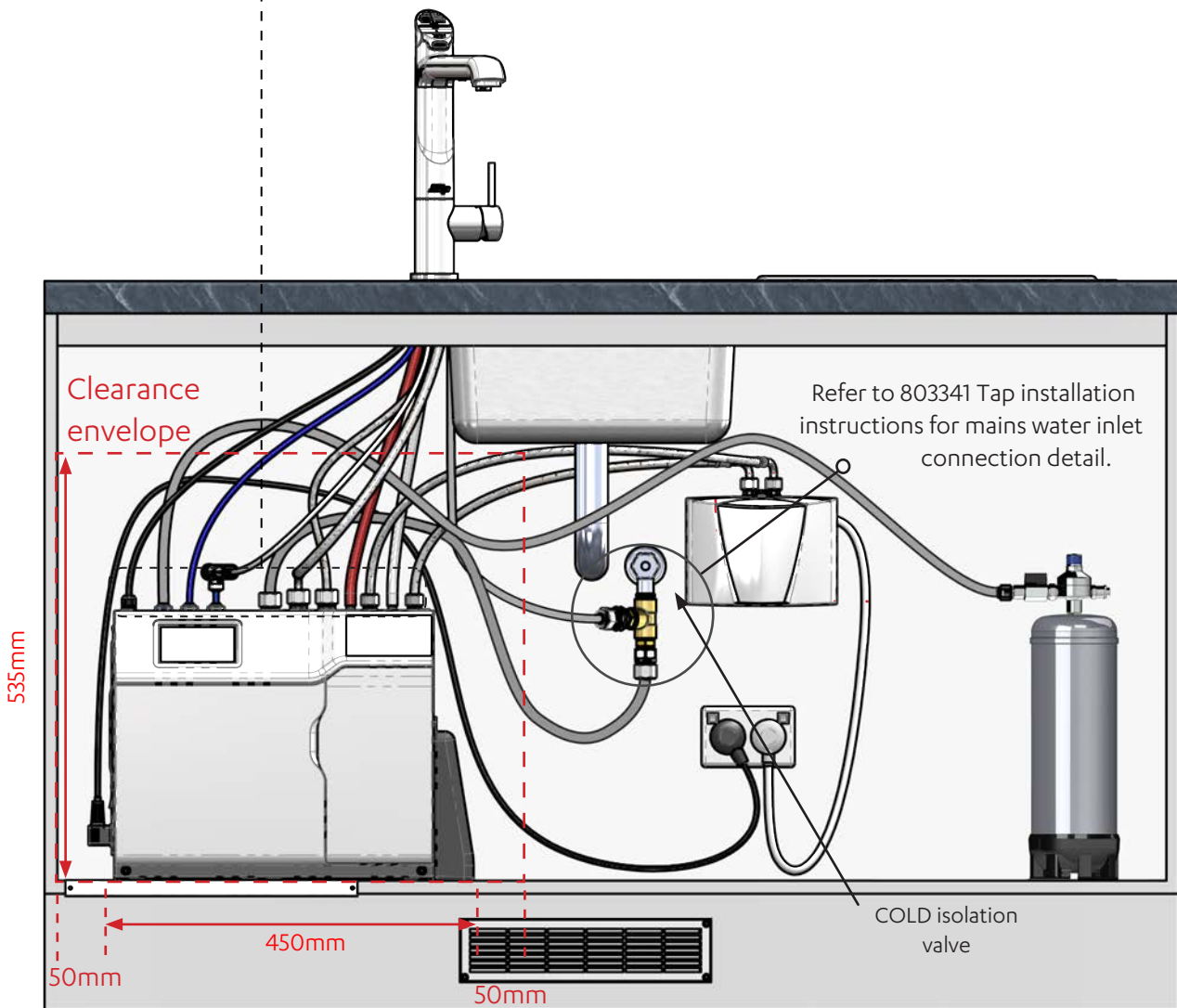
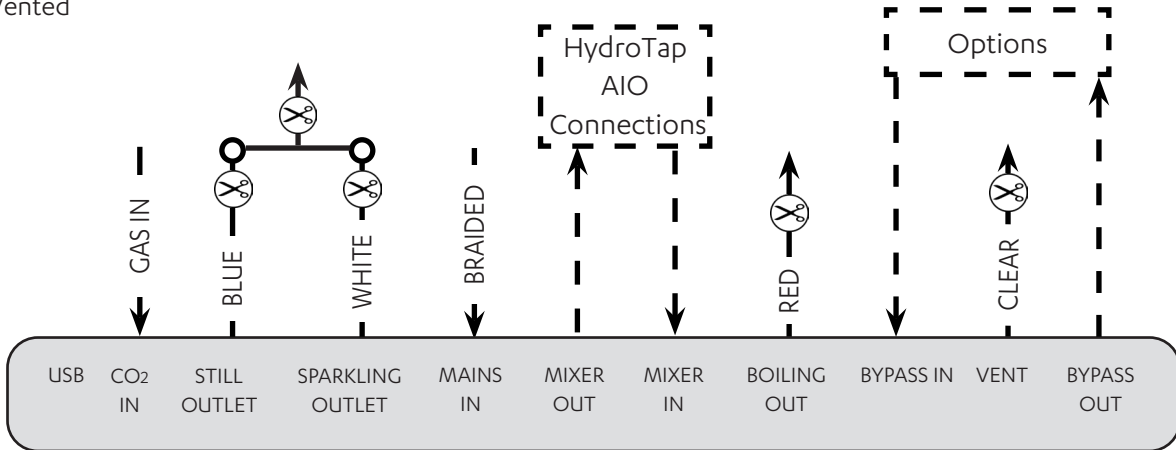

## 7.4 Command Centre installation

### 2957UK, 2857UK, 1456UK & 1256UK BCS Commercial & Residential compact

#### Table of contents

7.4.1 HydroTap G4 models.....	40
7.4.2 HydroTap G4 and mixer tap combinations (2957UK & 1456UK only) .....	41
7.4.3 All-in-One MAINS models.....	42
7.4.4 All-in-One VENTED models (2957UK & 1456UK only) .....	43

7.4.1 HydroTap G4 models

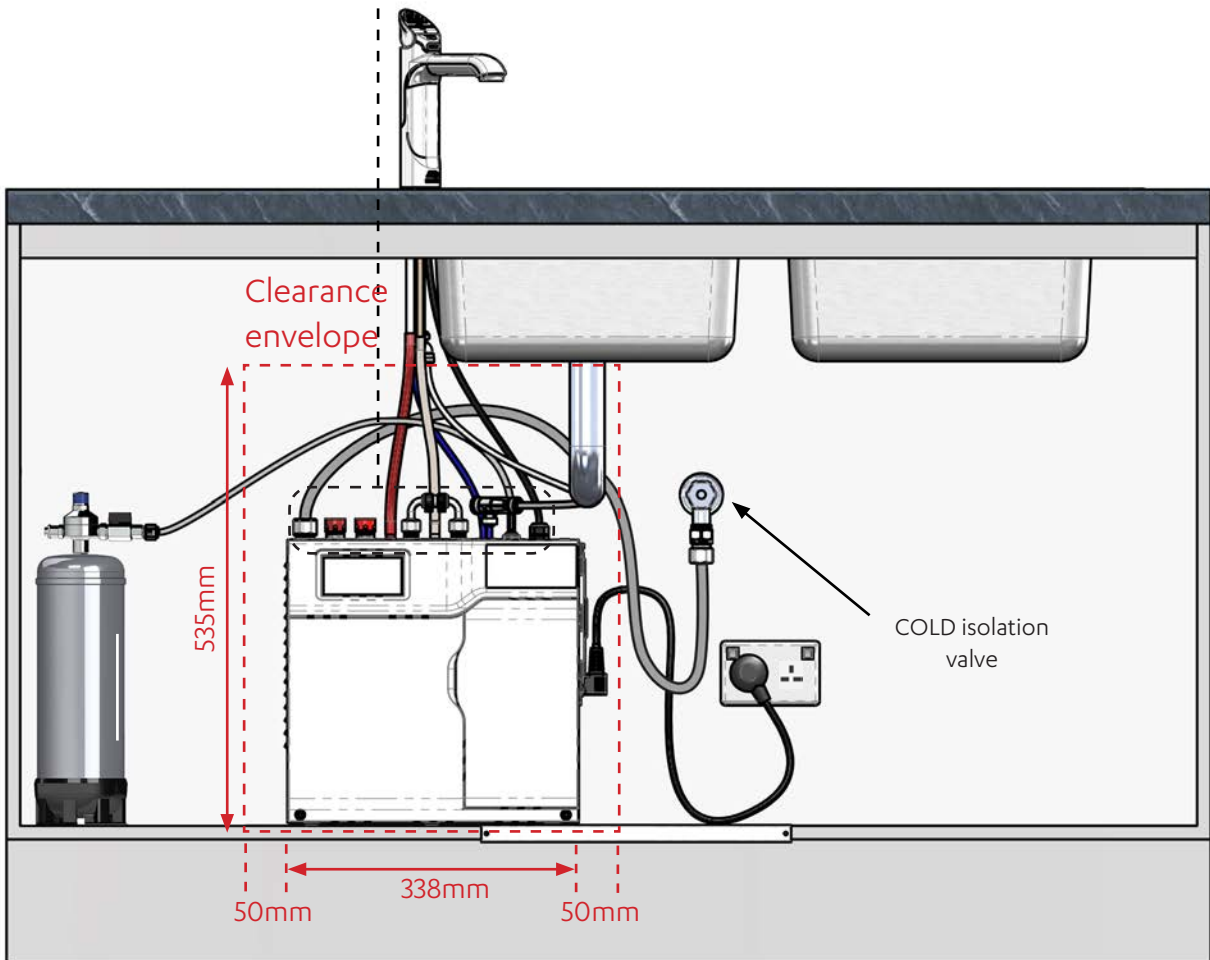
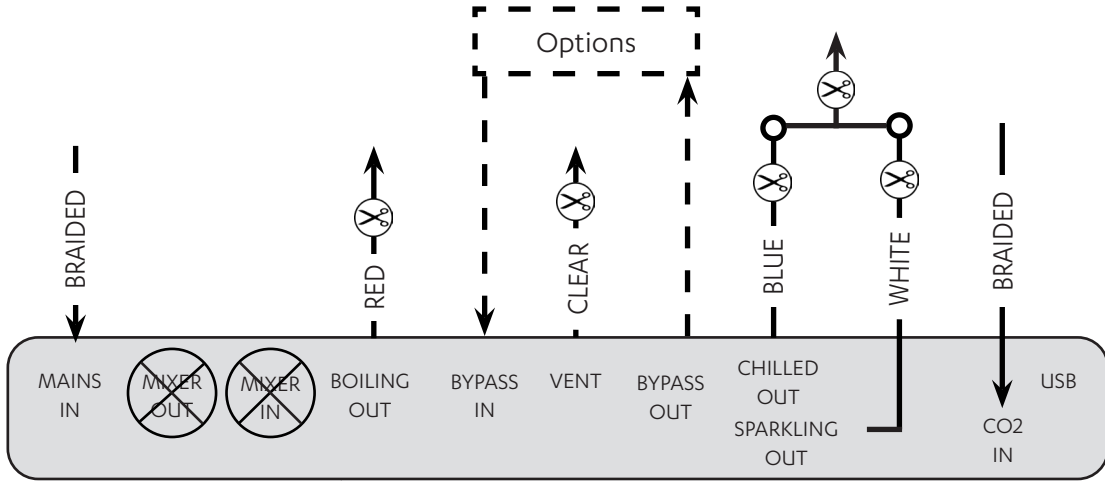



7.4.2 HydroTap G4 and mixer taps

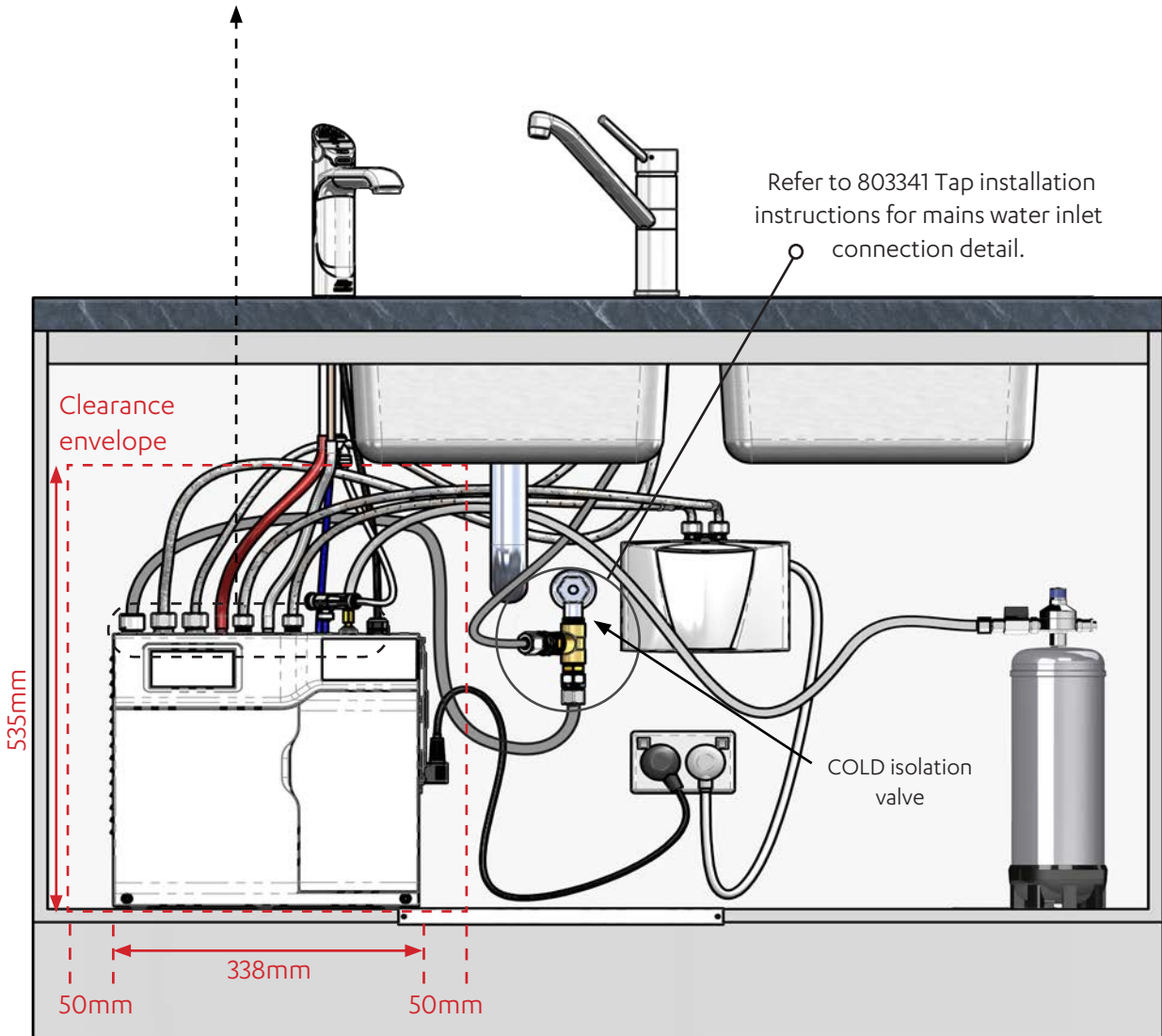
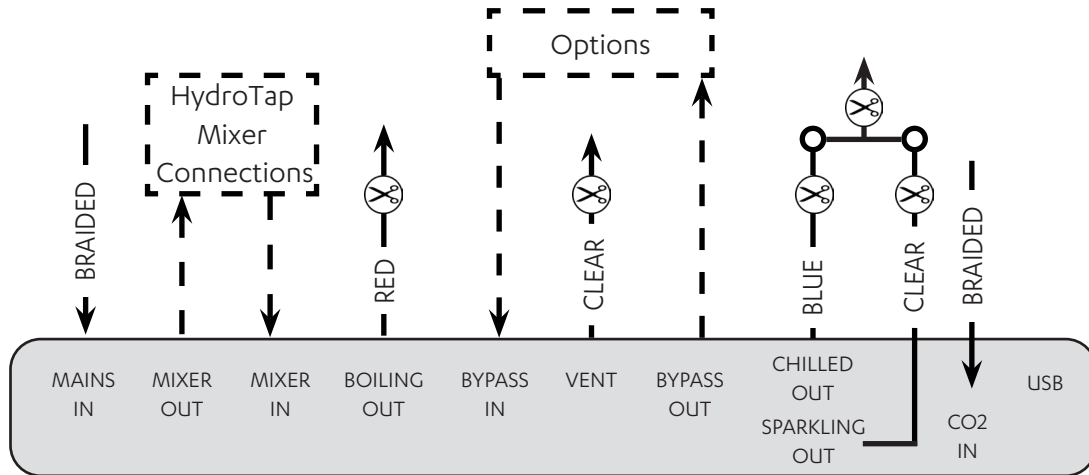
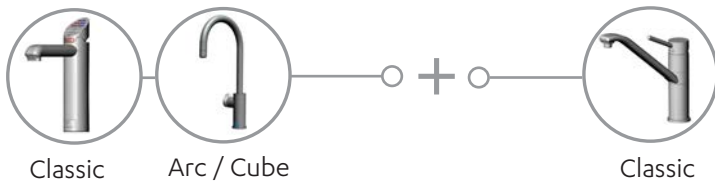

### 7.4.3 All-in-One 'Mains' tap

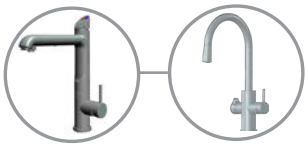

All-in-One Classic Mains    All-in-One Celsius Arc

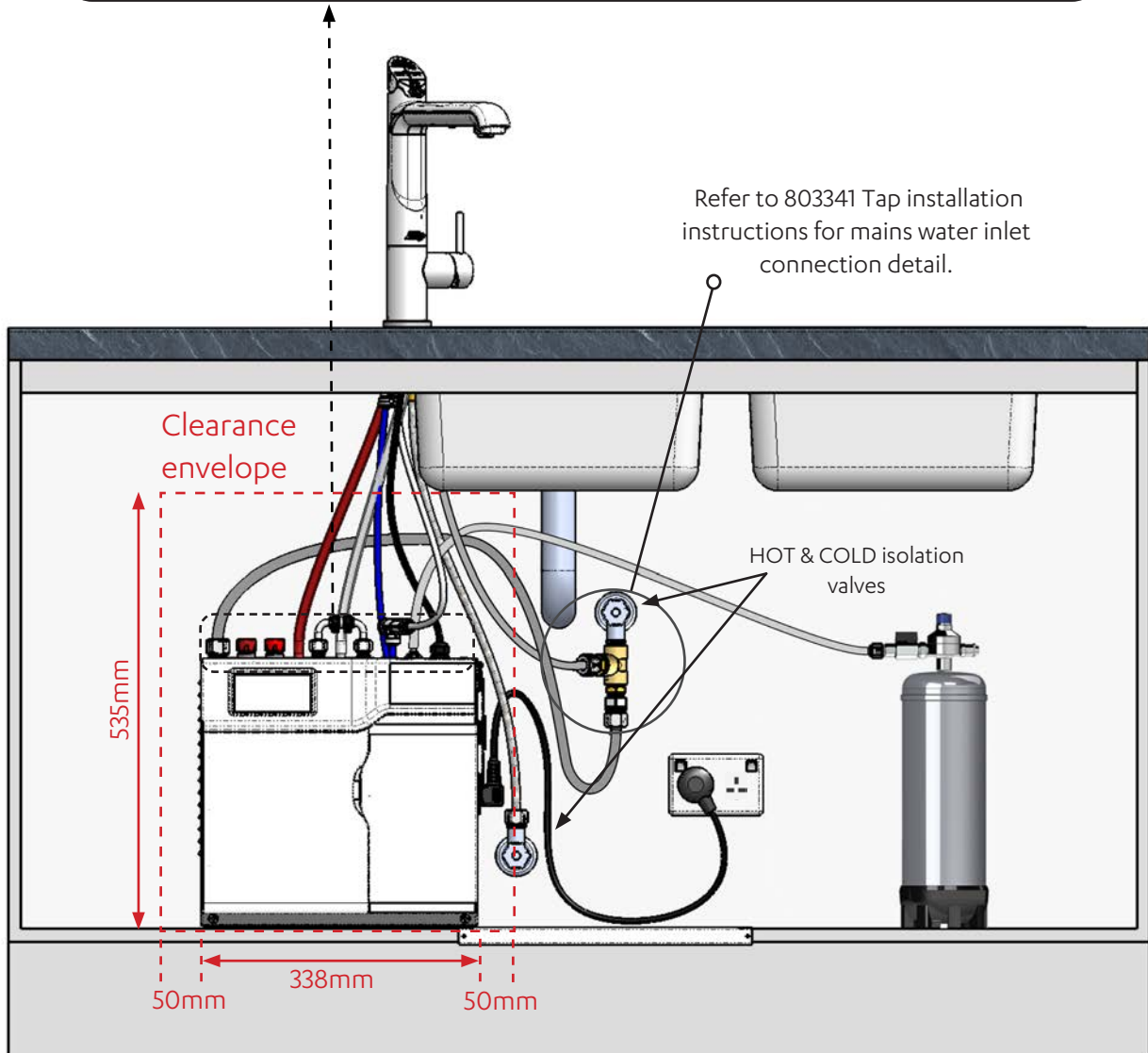
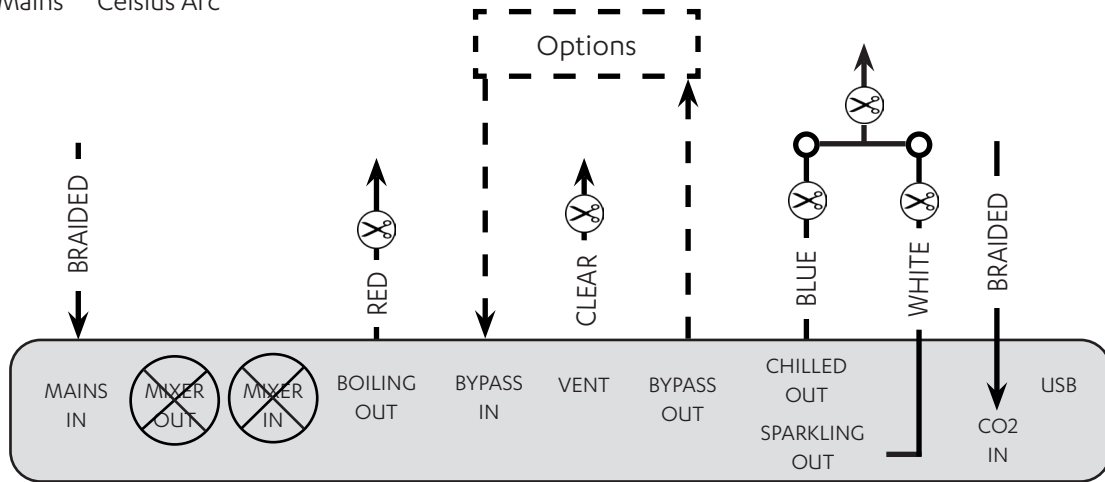

7.4.4 All-in-One Classic 'Vented' tap



All-in-One  
Classic  
Vented

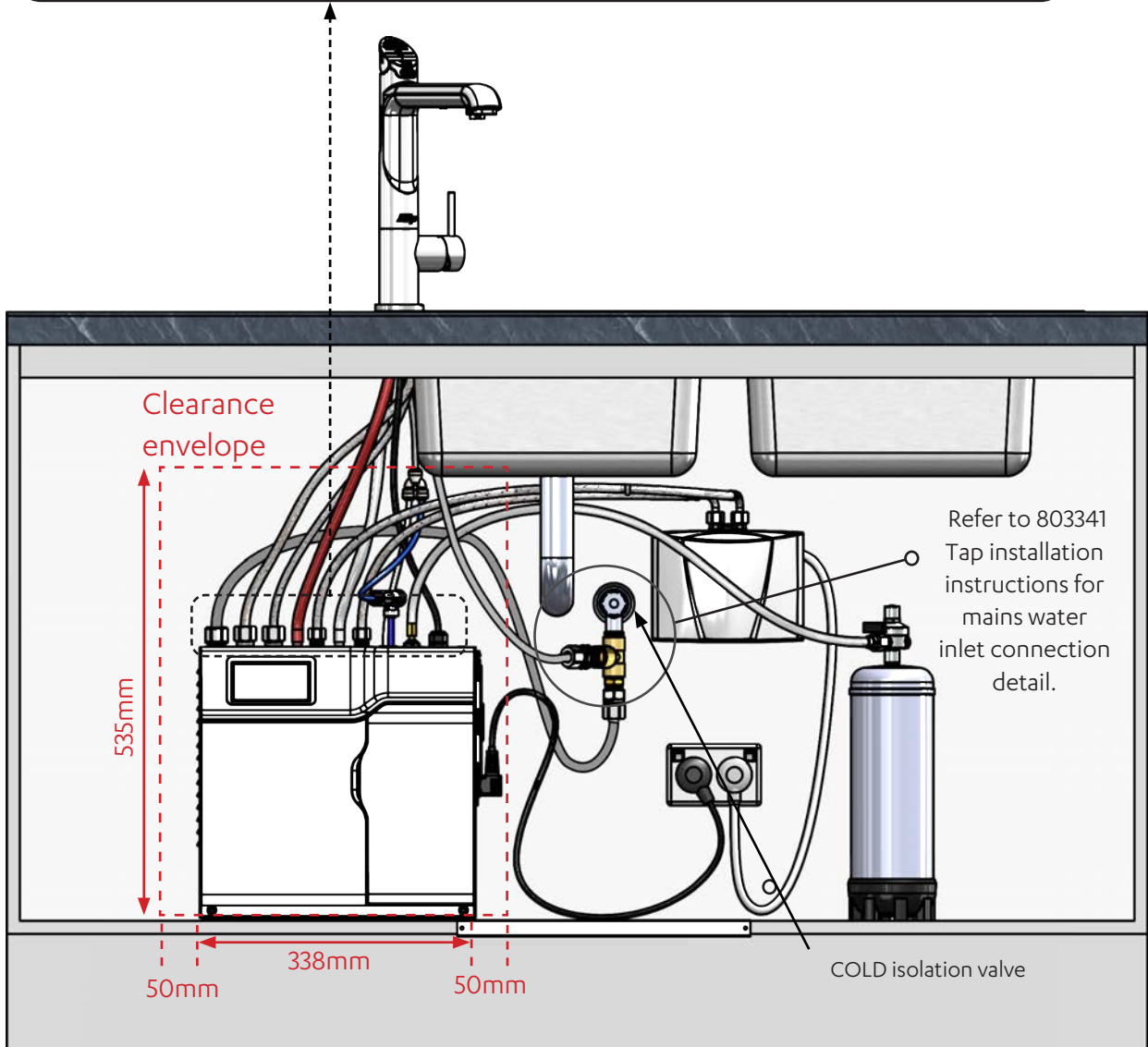
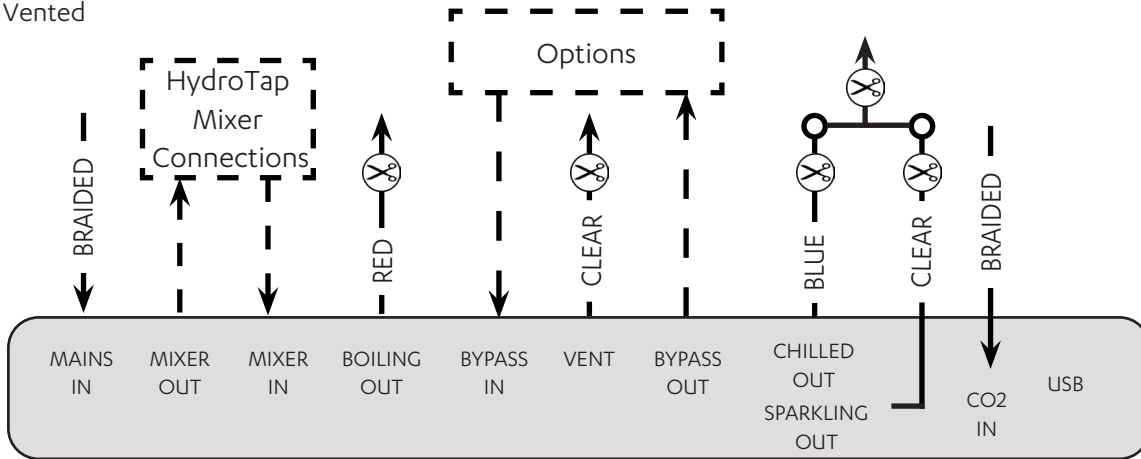

## 7.5 Command Centre installation 5261UK & 5061UK BC Commercial

### Table of contents

7.5.1 HydroTap G4 models .....	45
7.5.2 HydroTap G4 and mixer tap combinations (5261UK only) .....	46
7.5.3 All-in-One MAINS models .....	47
7.5.4 All-in-One VENTED models (5261UK only) .....	48

7.5.1 HydroTap G4 models



Classic

Arc / Cube

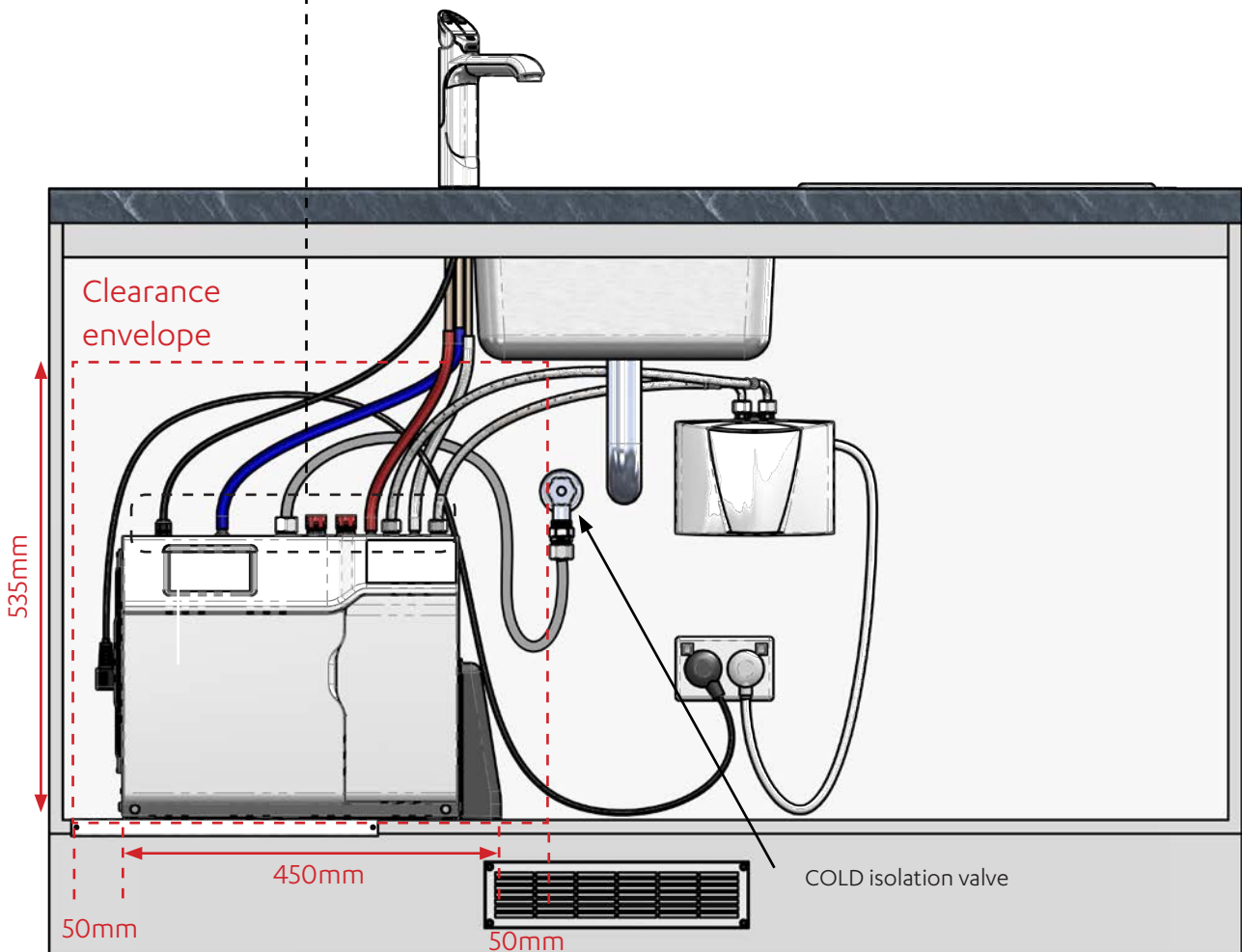
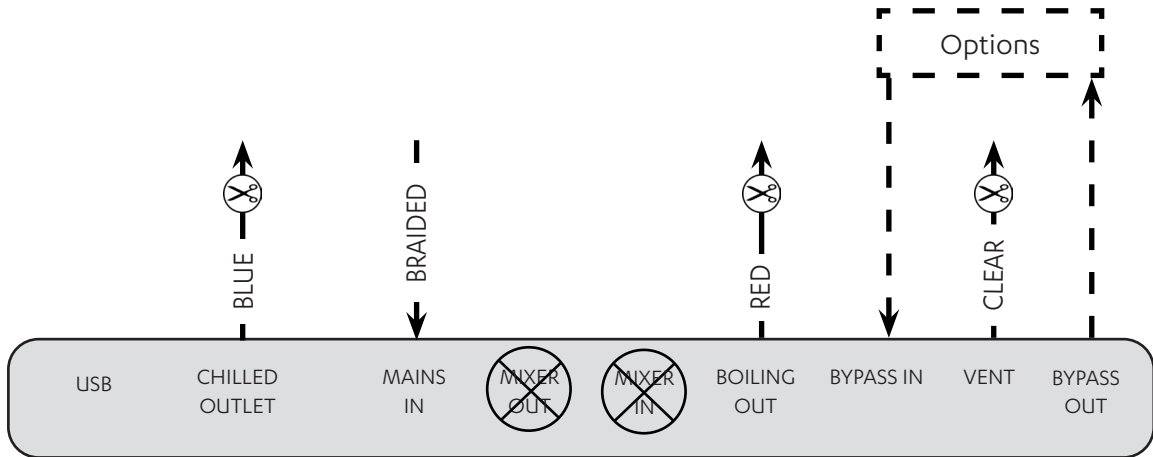

### 7.5.2 HydroTap G4 and mixer tap combinations

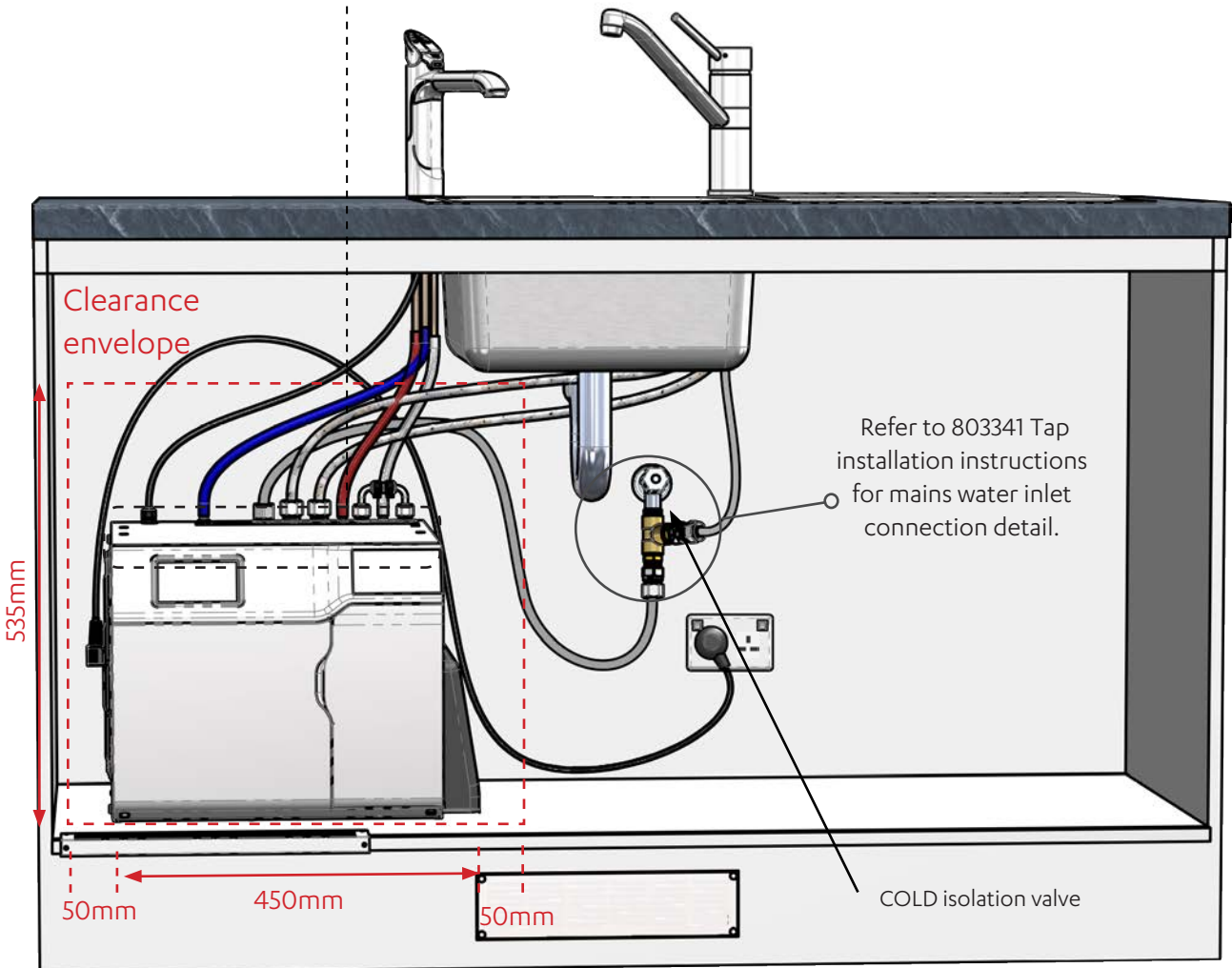
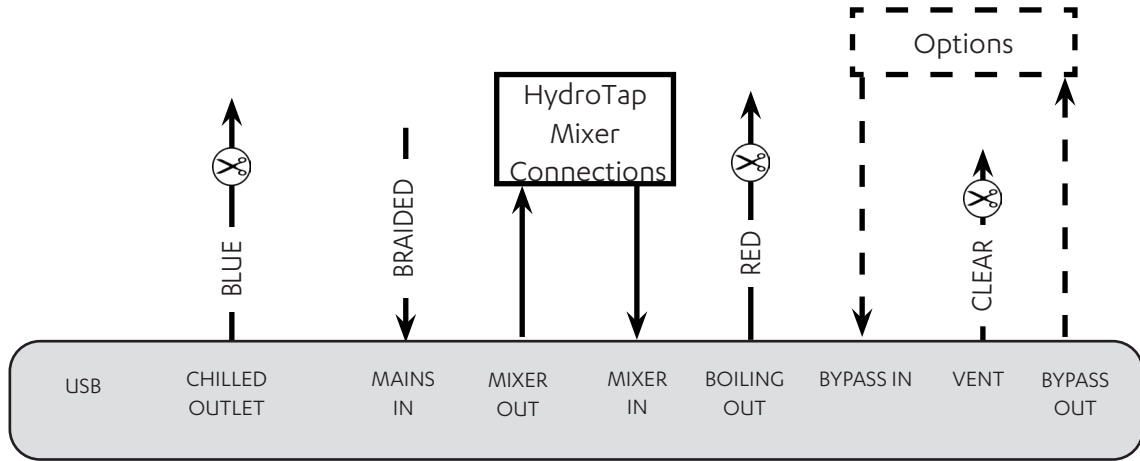
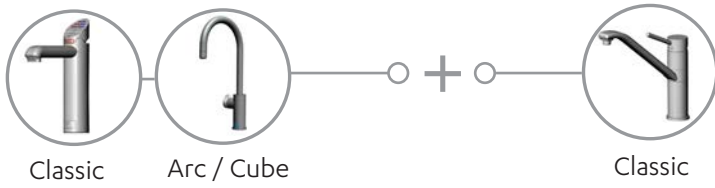

### 7.5.3 All-in-One 'Mains' tap

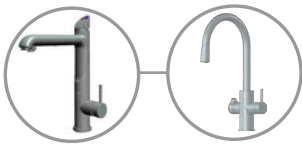

All-in-One Classic Mains

All-in-One Celsius Arc

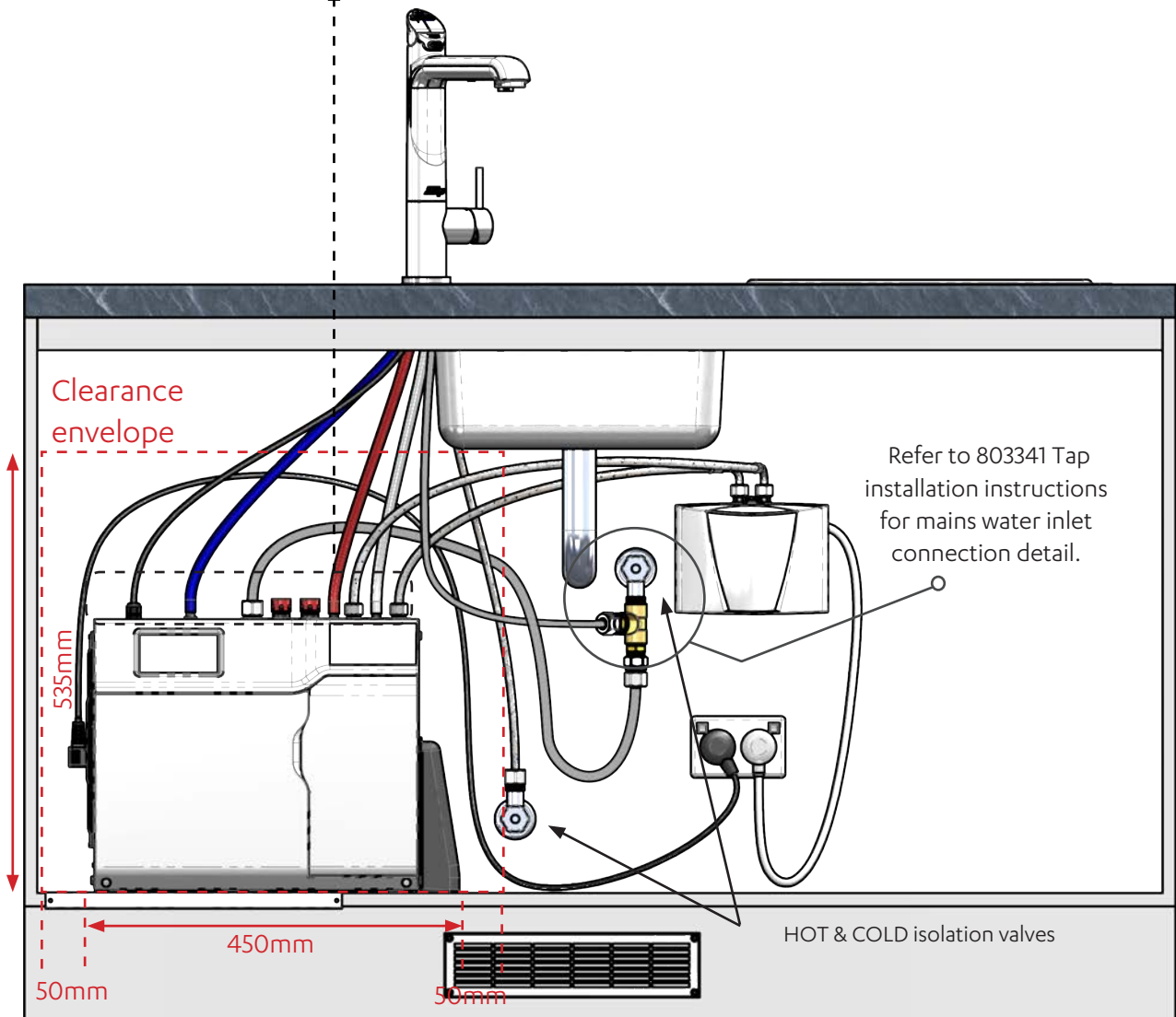
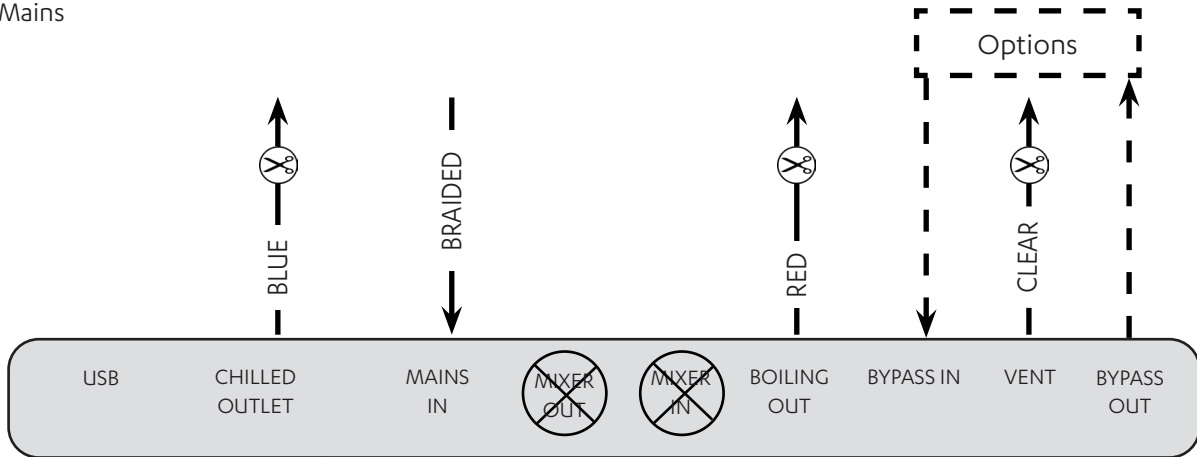

7.5.4 All-in-One Classic 'Vented' tap



All-in-One  
Classic  
Vented

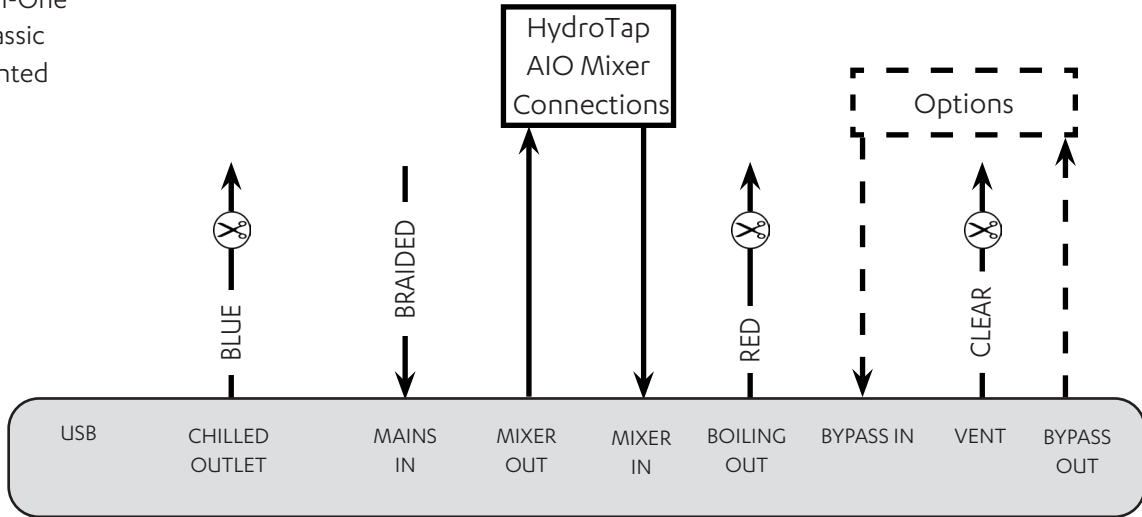

Refer to 803341 Tap installation instructions for mains water inlet connection detail.

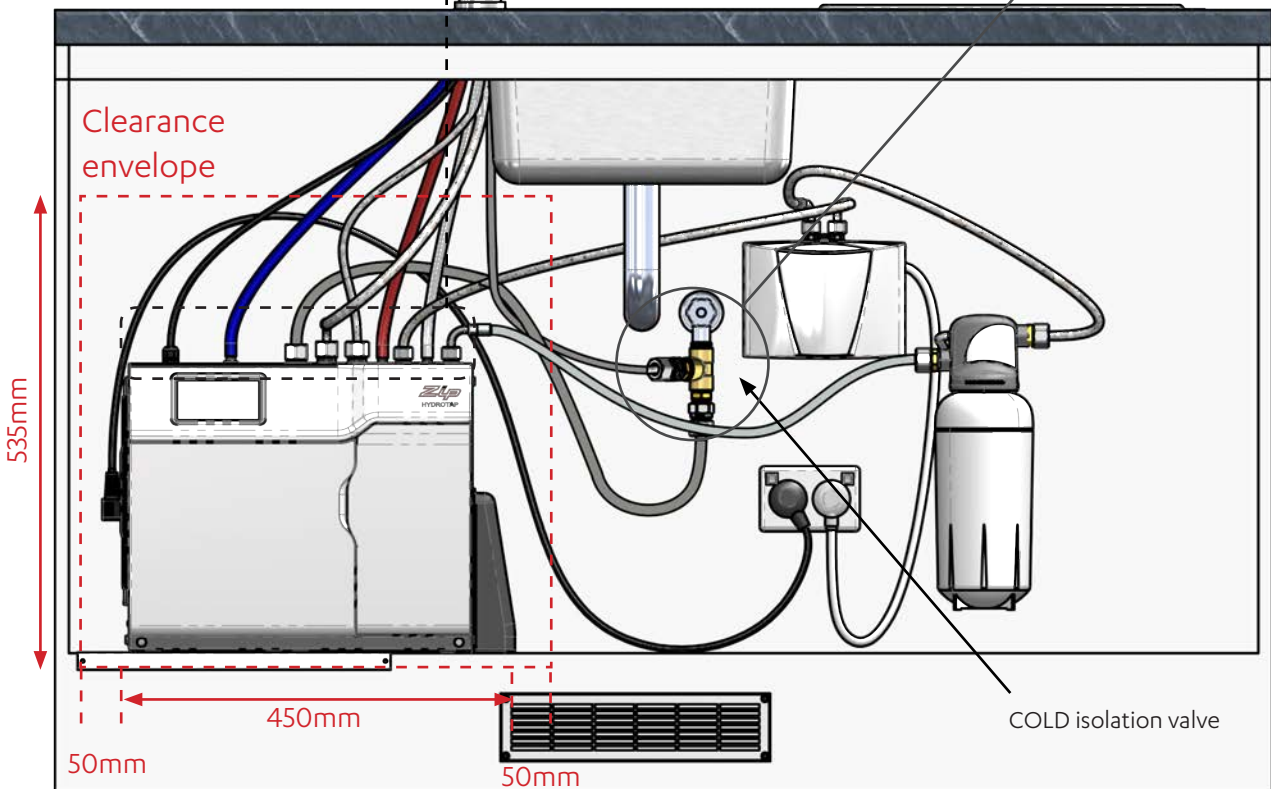



## 7.6 Command Centre installation 2924UK, 2824UK, 1414UK & 1214UK BC Commercial & Residential compact

### Table of contents

7.6.1 HydroTap G4 models.....	50
7.6.2 HydroTap G4 and mixer tap combinations (2924UK & 1414UK only) .....	51
7.6.3 All-in-One MAINS models .....	52
7.6.4 All-in-One VENTED models (2924UK & 1414UK only) .....	53

7.6.1 HydroTap G4 models

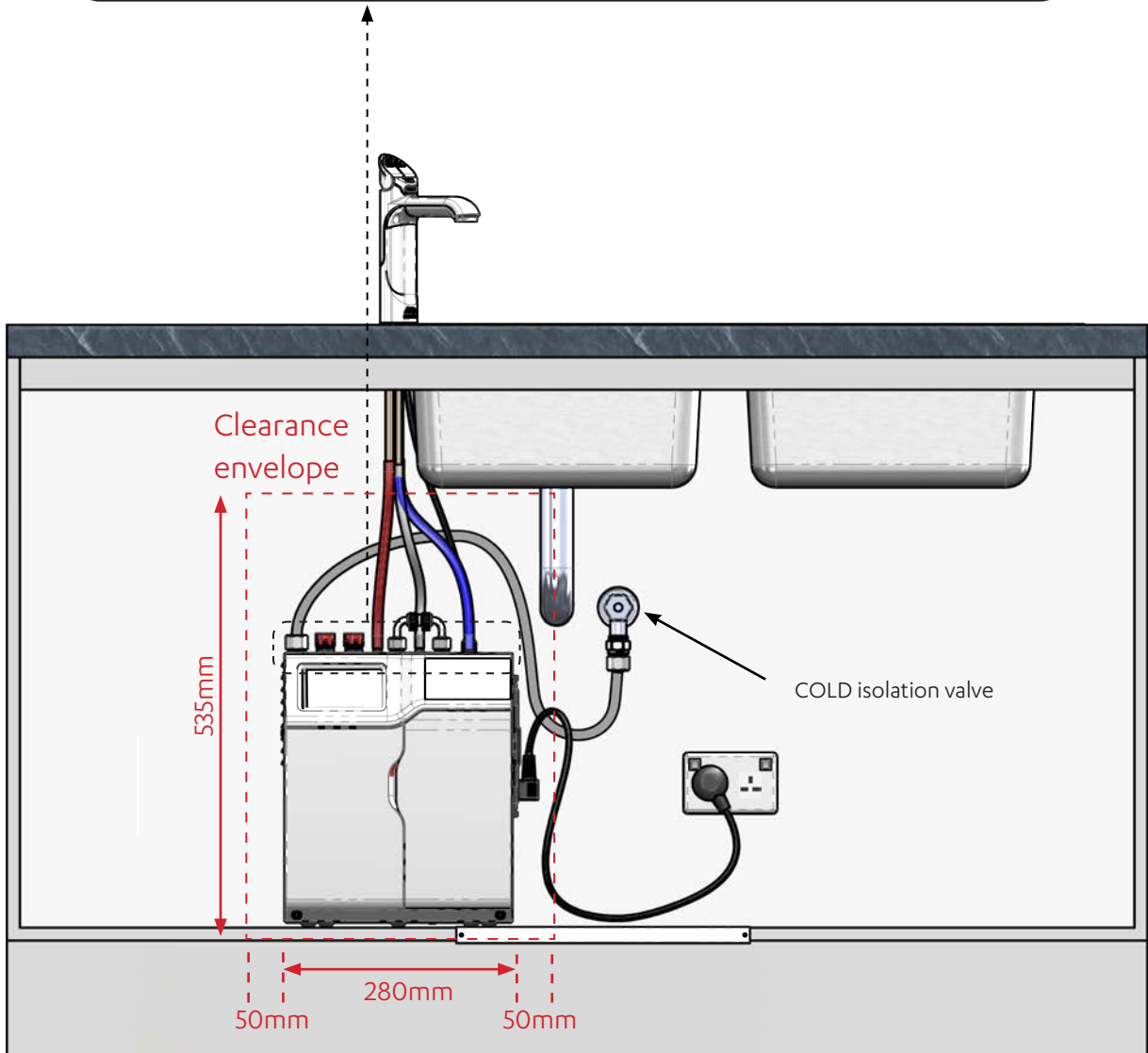
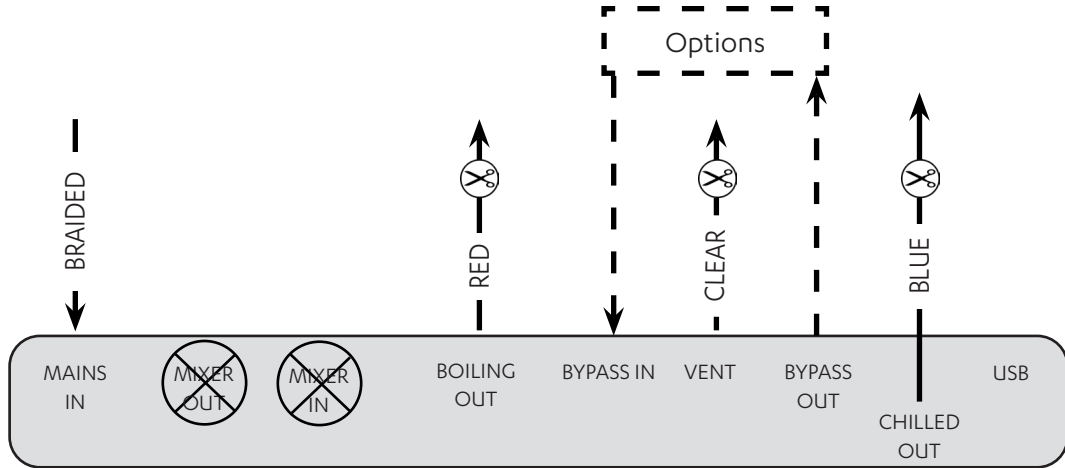

### 7.6.2 HydroTap G4 and mixer tap combinations

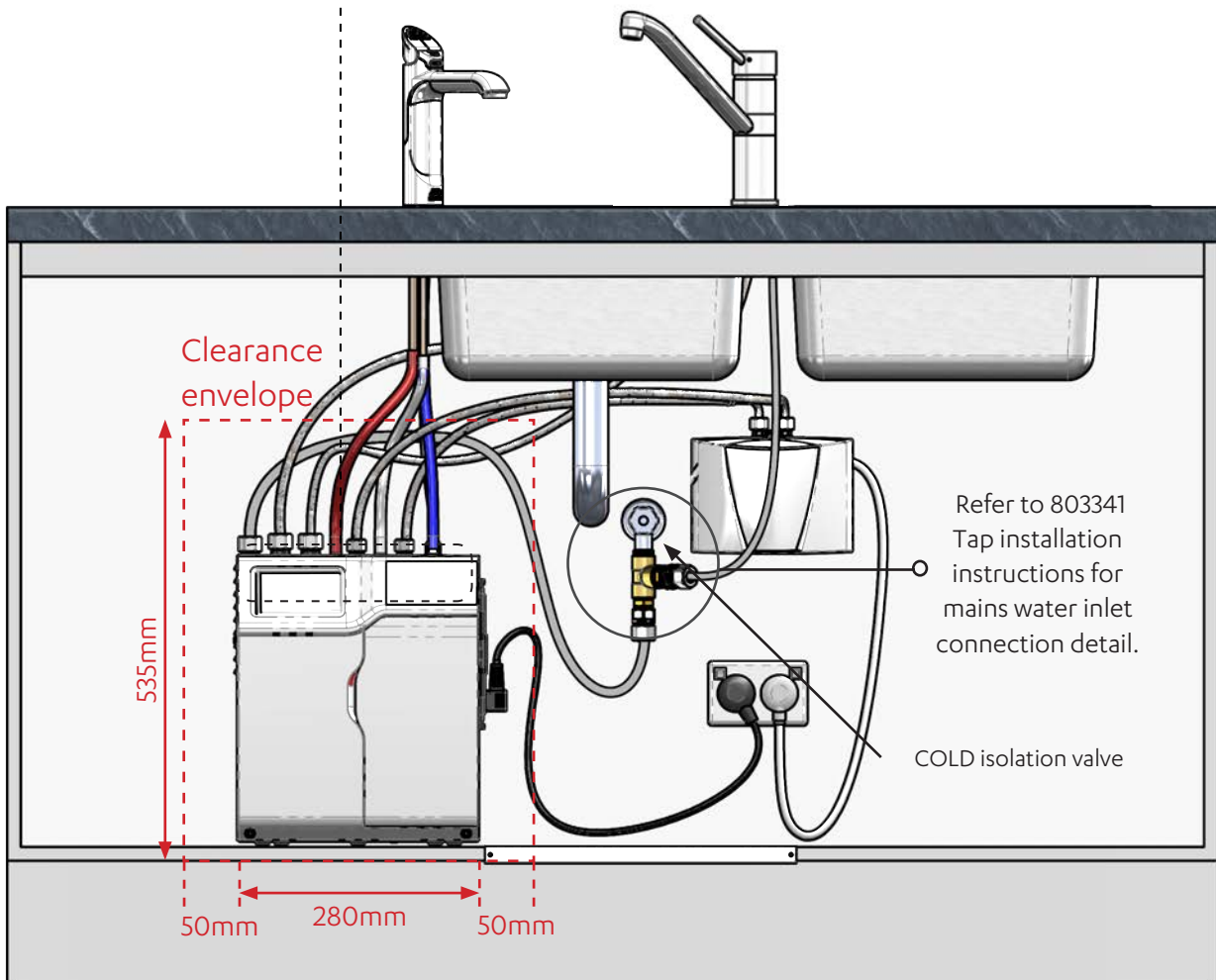
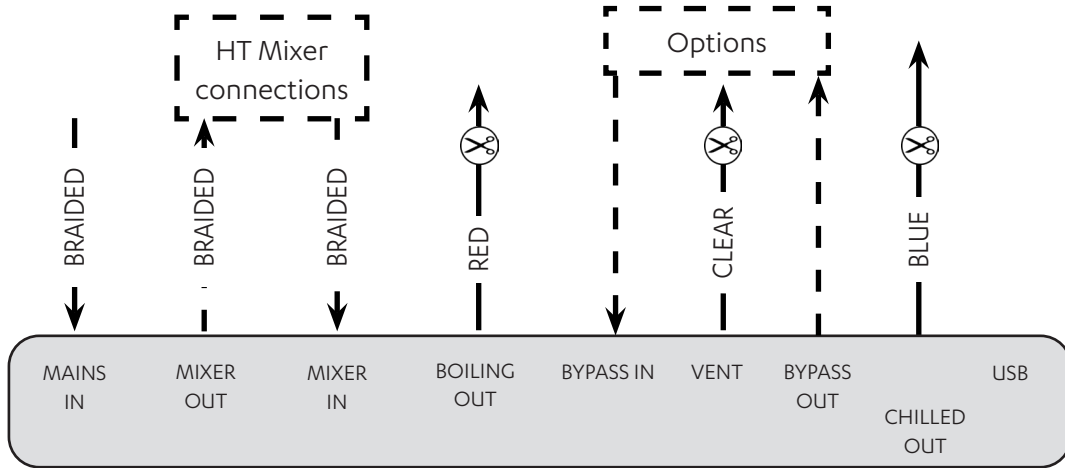
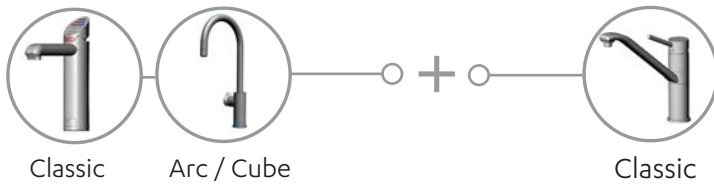

### 7.6.3 All-in-One 'Mains' tap

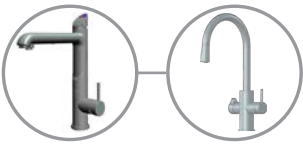

All-in-One Classic Mains

All-in-One Celsius Arc

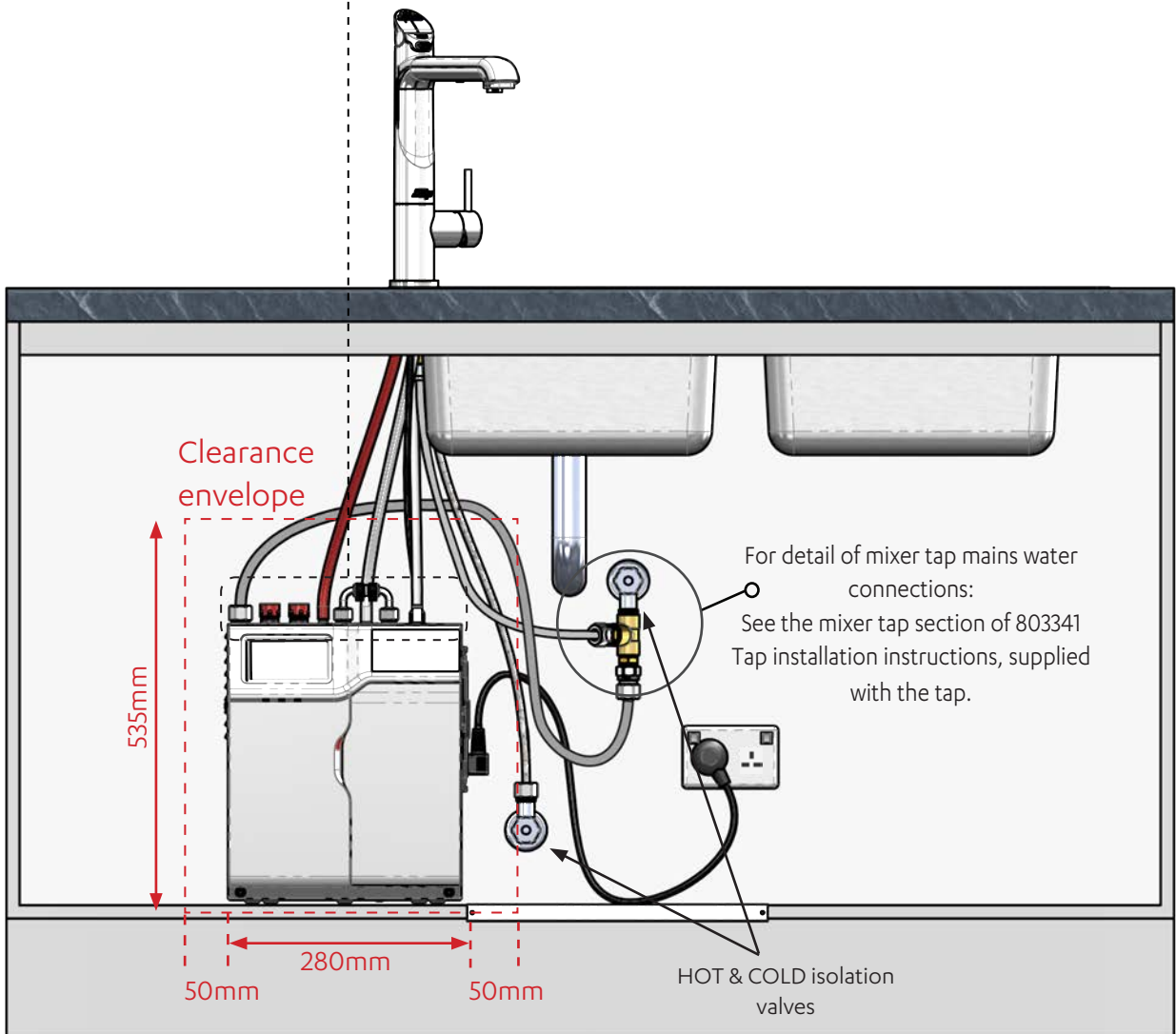
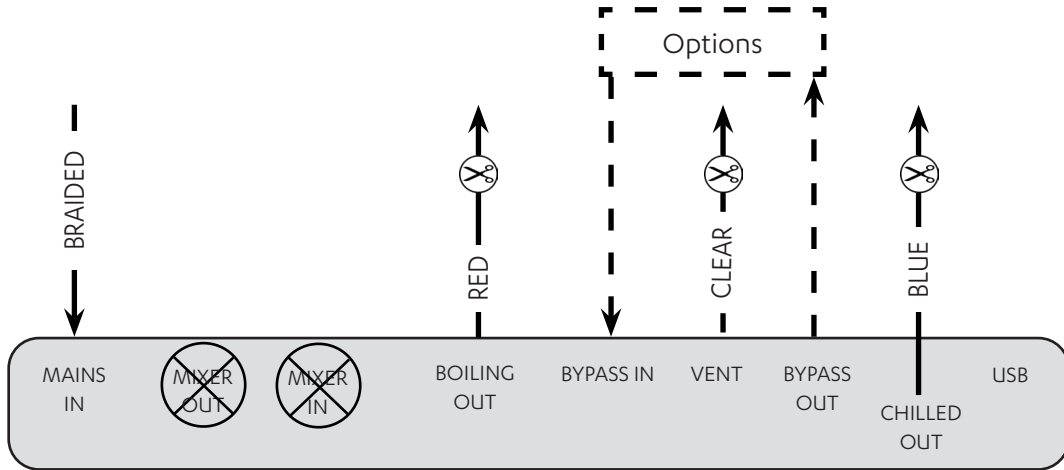

7.6.4 All-in-One Classic 'Vented' tap



All-in-One Classic Vented

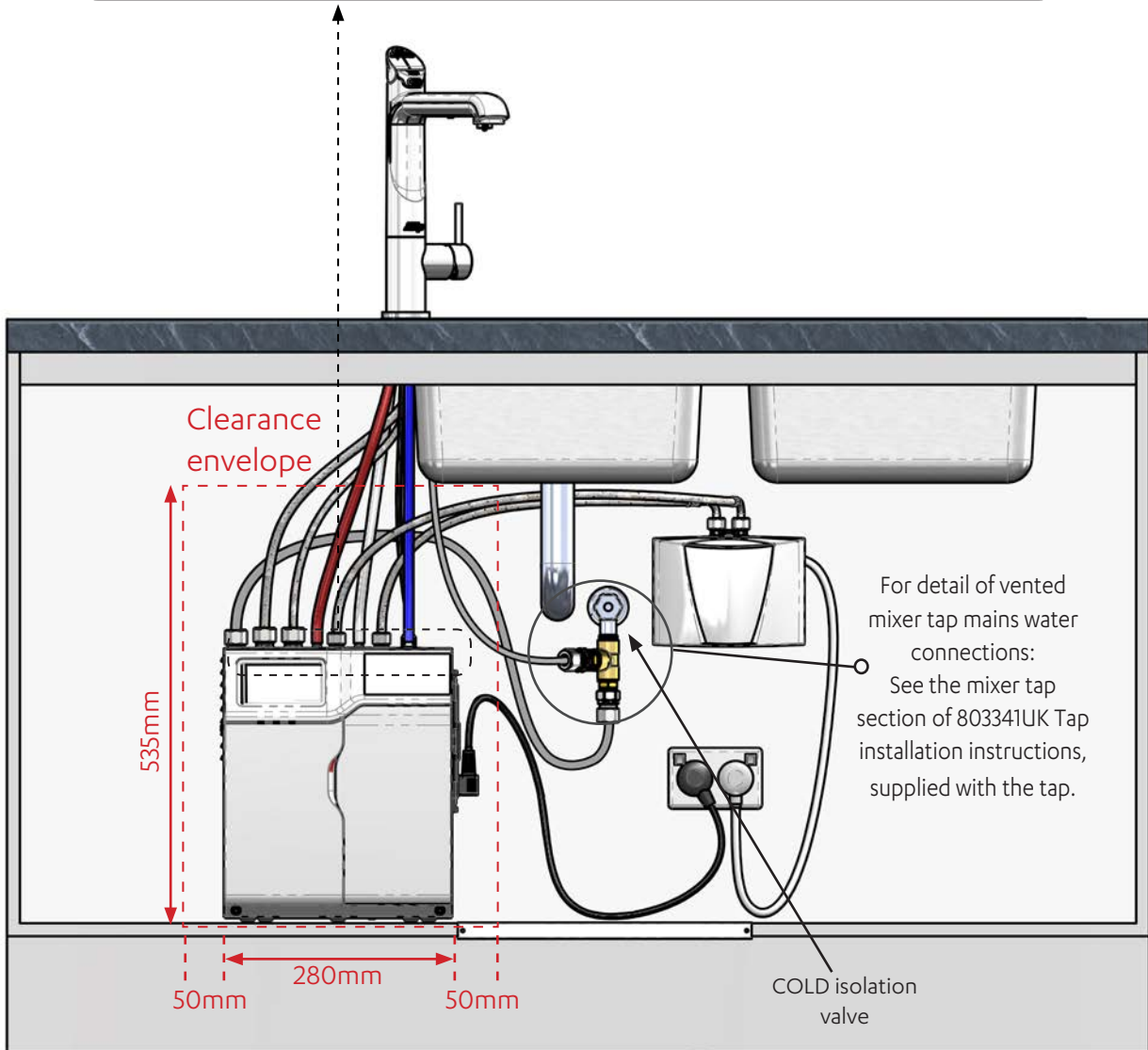
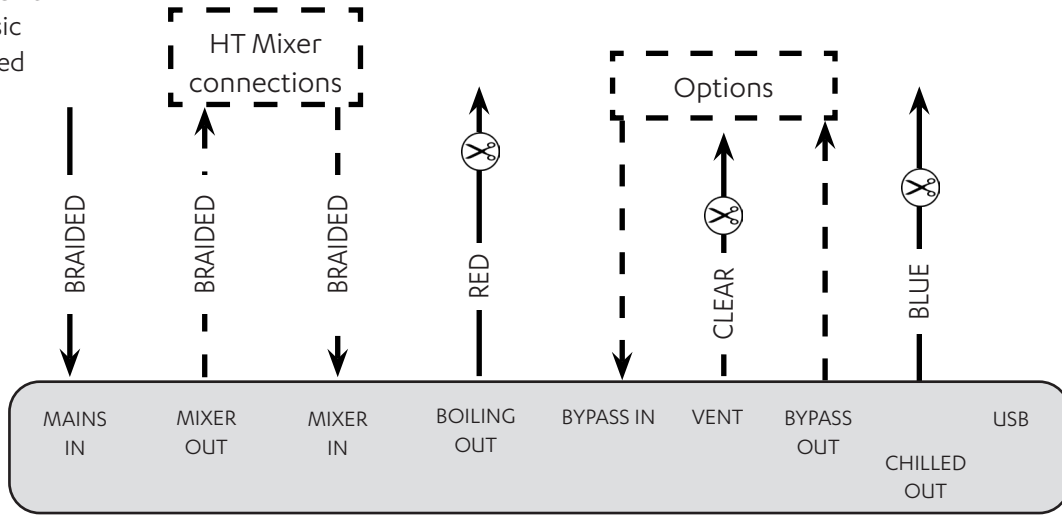

## 7.7 Command Centre installation

5201UK, 5200UK, 5001UK, 5000UK, 1500UK & 1300UK

BO BA Commercial and BO Residential

### Table of contents

7.7.1 HydroTap G4 Boiling models .....	55
7.7.2 HydroTap G4 Boiling and Ambient models .....	56
7.7.3 HydroTap G4 Boiling and mixer tap combinations (5200UK, 1500UK only) .....	57
7.7.4 HydroTap G4 Boiling and Ambient plus mixer tap combinations (5201UK only) .....	58
7.7.5 Celsius Boiling plus unfiltered Hot and Cold models .....	59
7.7.6 All-in-One Celsius Arc Boiling and Ambient plus unfiltered Hot and Cold models.....	60

7.7.1 HydroTap G4 boiling models

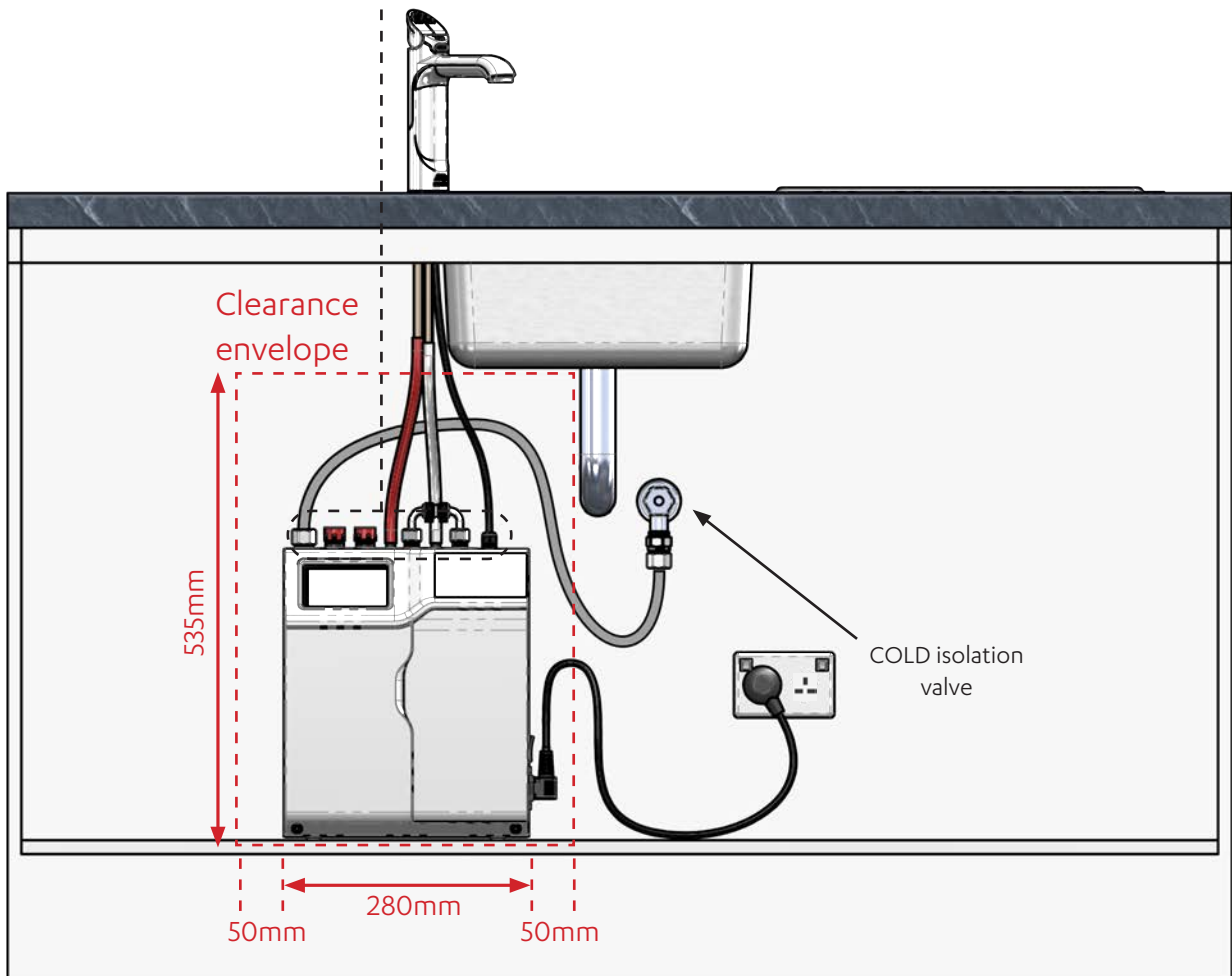
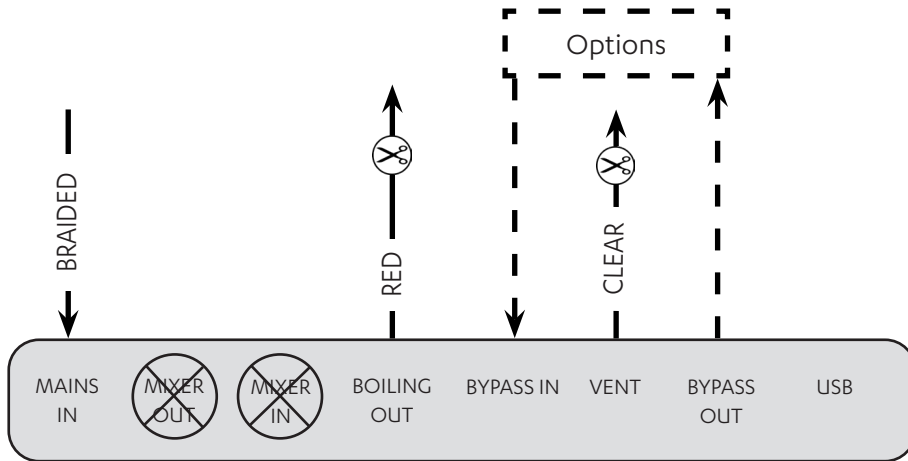

### 7.7.2 HydroTap G4 boiling ambient models

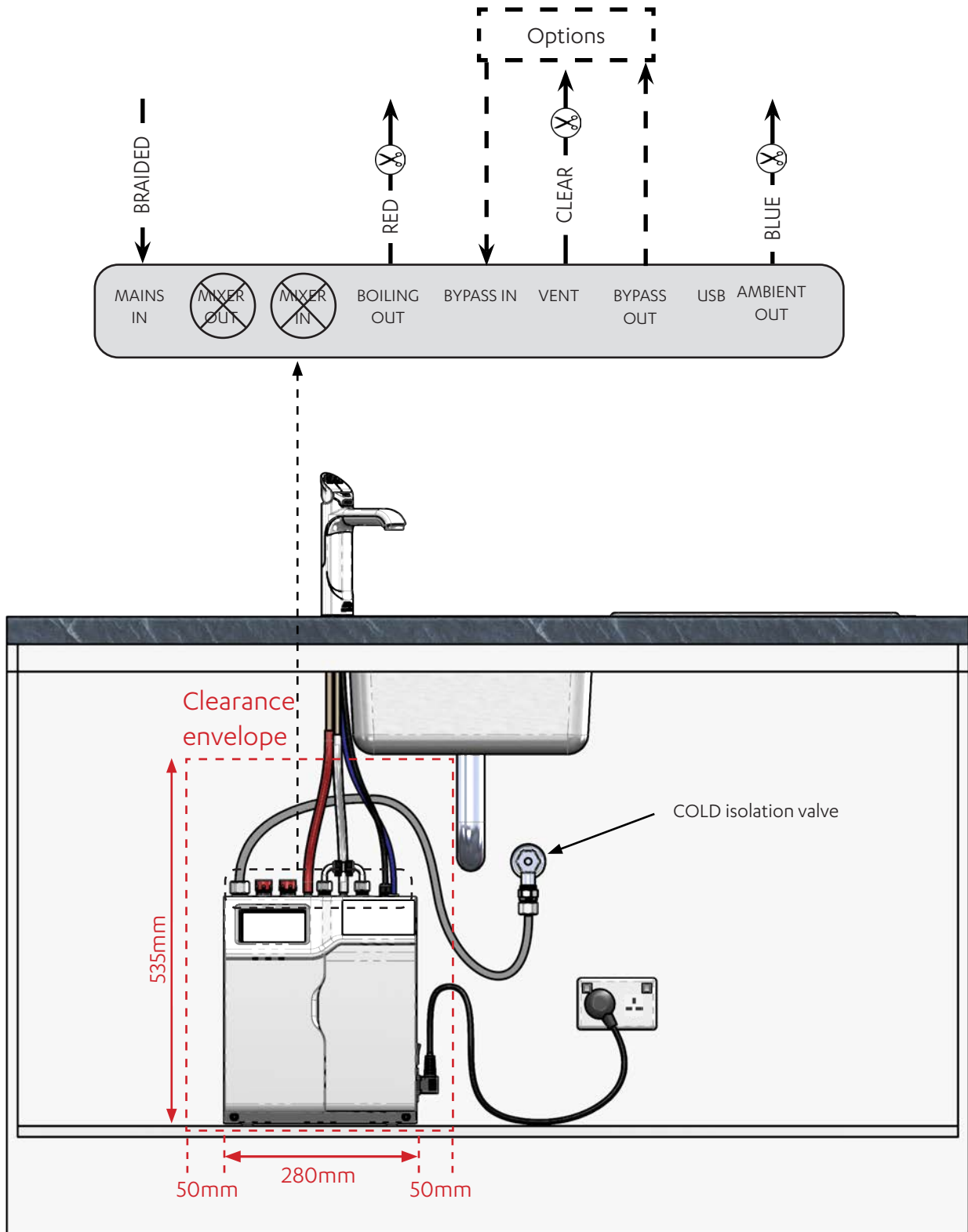



### 7.7.3 HydroTap G4 boiling and mixer tap combinations

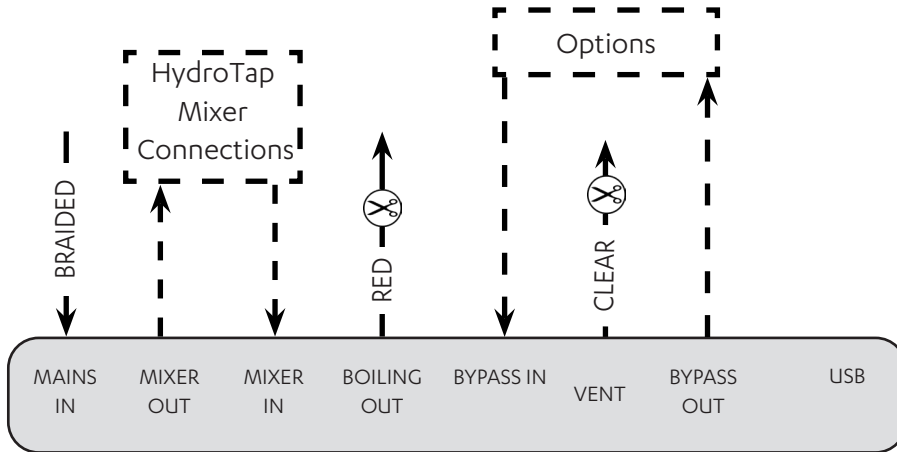
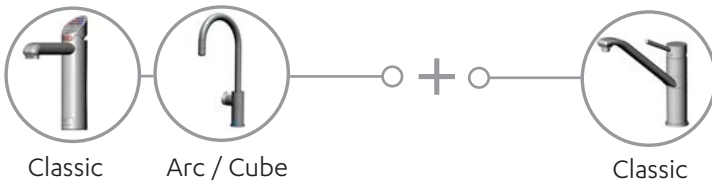

For detail of vented mixer tap mains water connections: See the mixer tap section of 803341 Tap installation instructions, supplied with the tap.

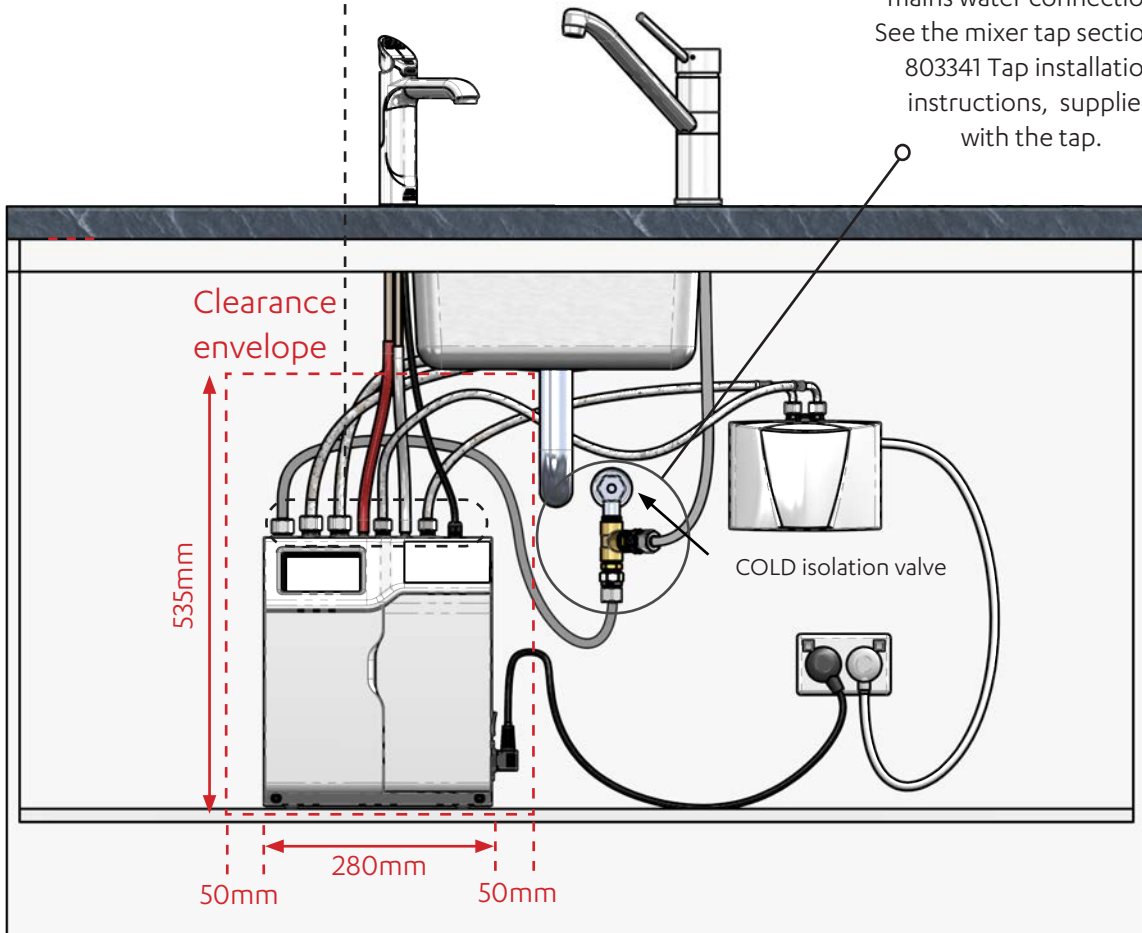

### 7.7.4 HydroTap G4 boiling ambient and mixer tap combinations

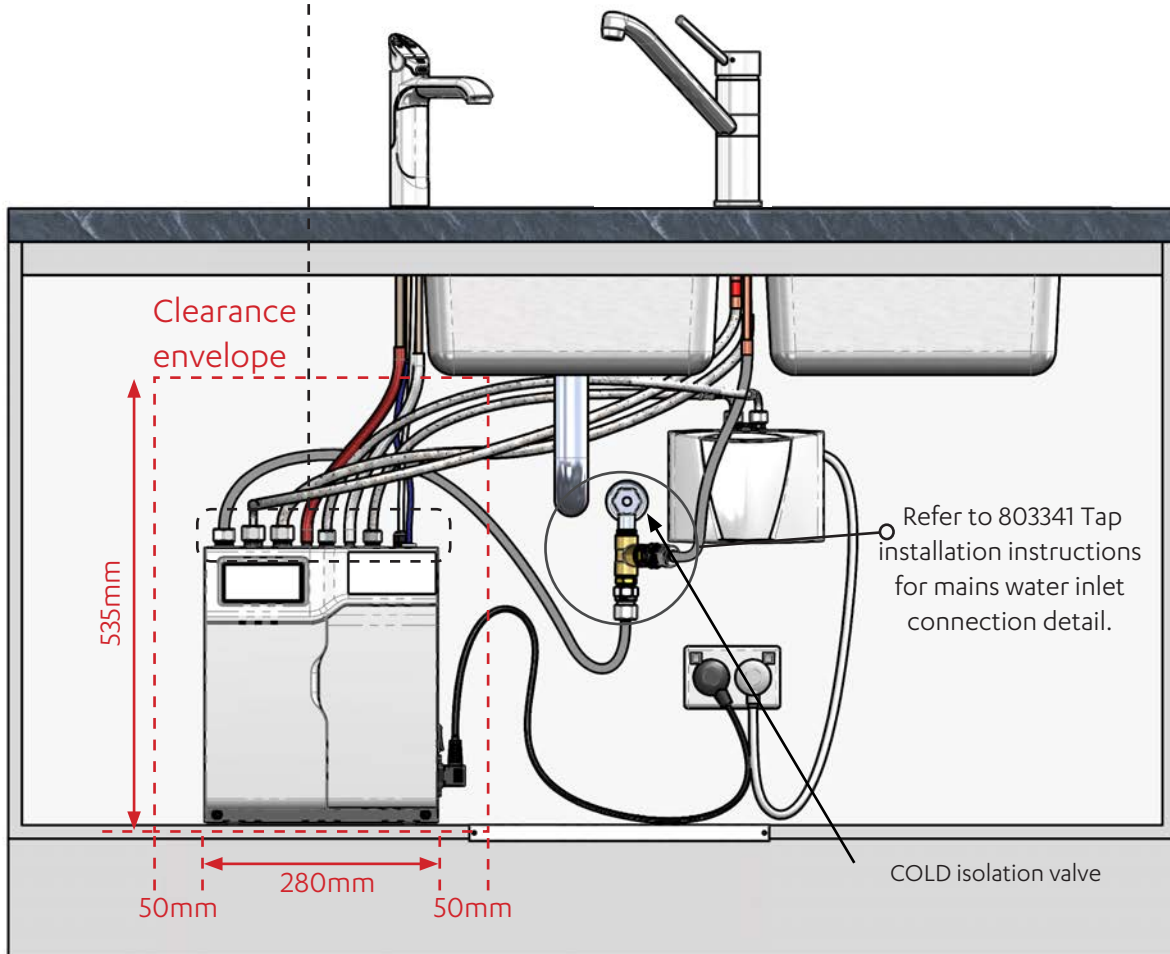
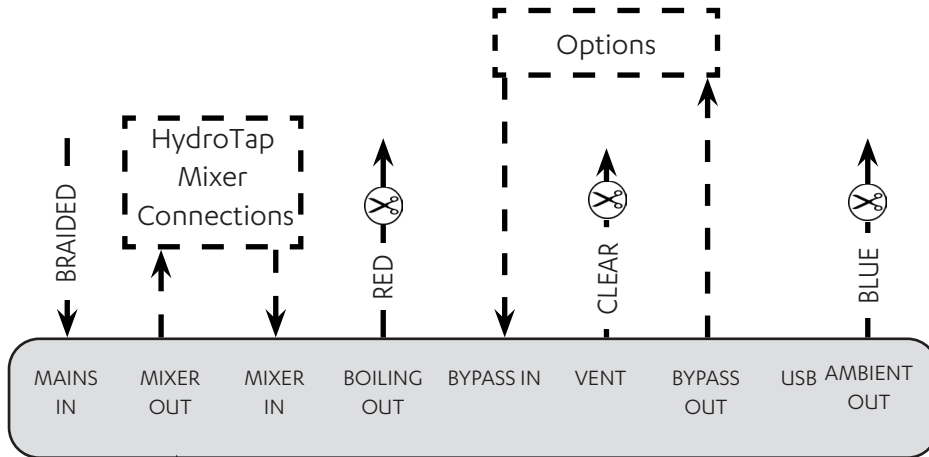
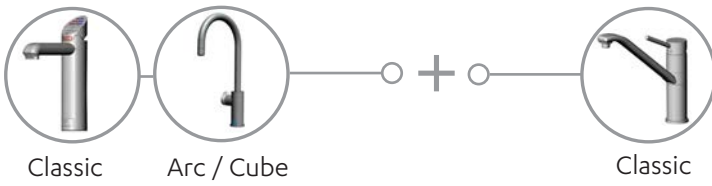

### 7.7.5 HydroTap G4 boiling with integral mixer tap models

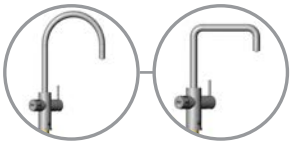

Celsius Arc Celsius Cube

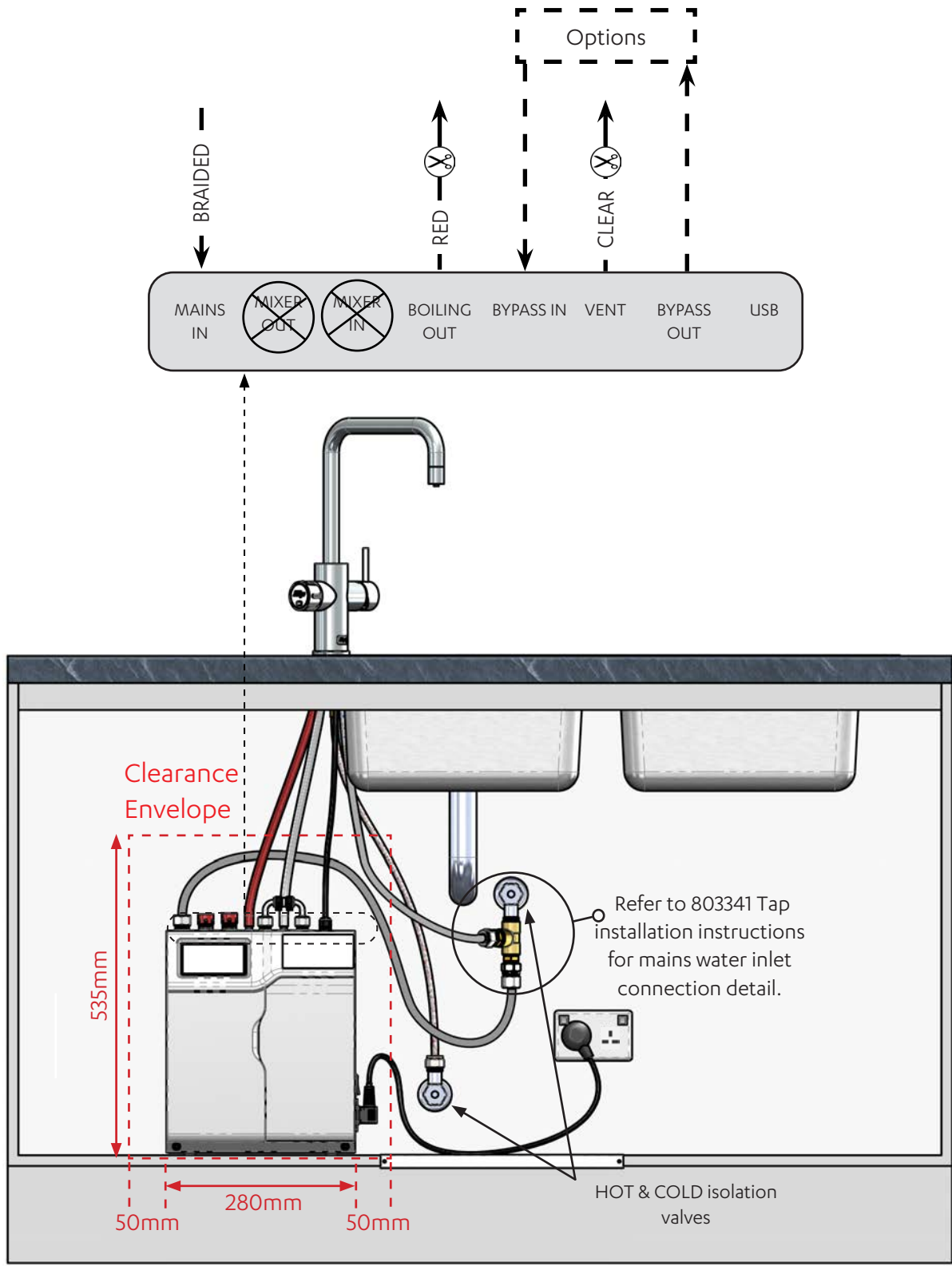

### 7.7.6 HydroTap G4 boiling ambient with integral mixer tap models



All-in-One  
Celsius Arc

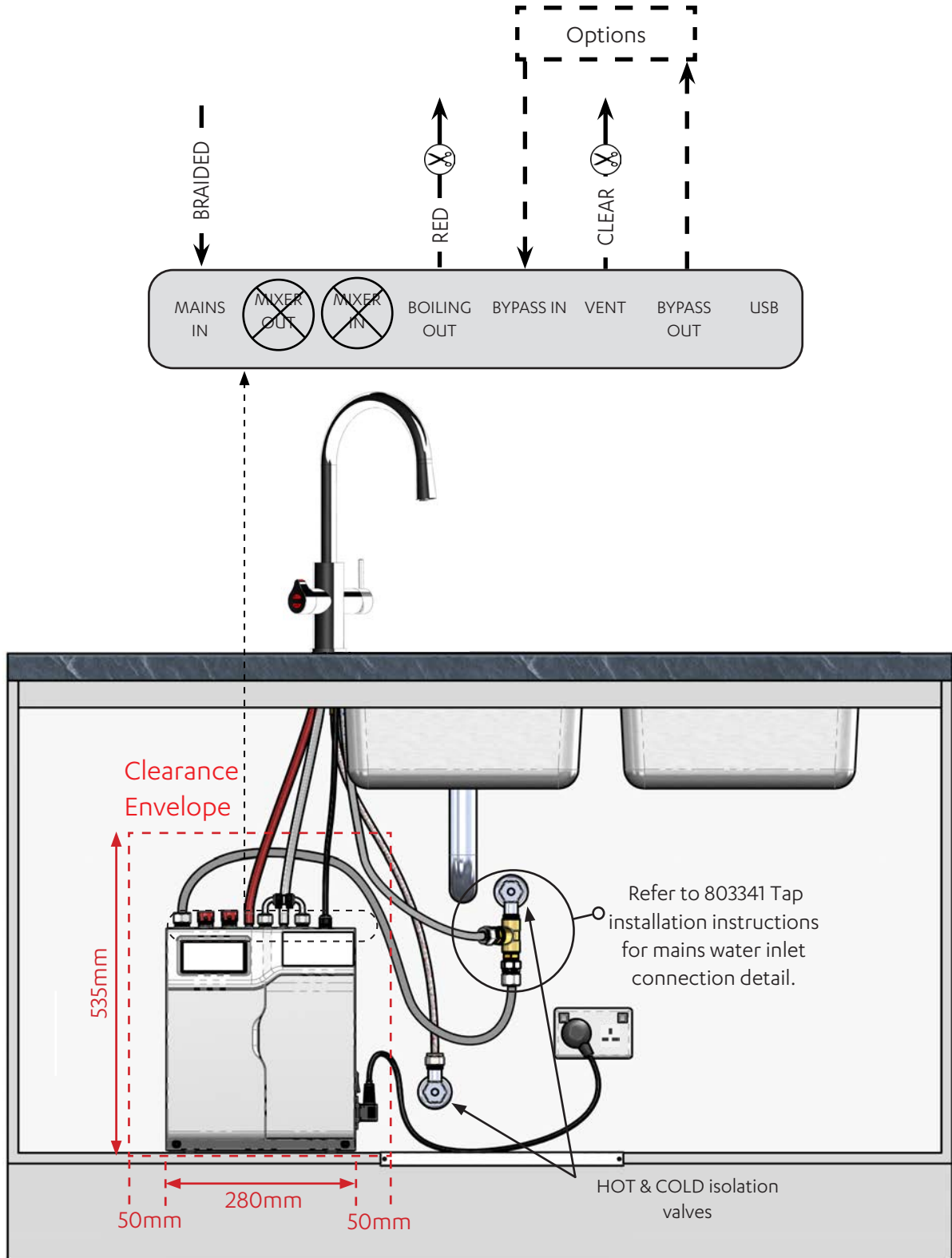

## 7.8 Command Centre installation

### 0053UK CS Commercial

#### Table of contents

7.8.1 HydroTap models .....	62
7.8.2 Celsius models.....	63

### 7.8.1 Chilled and sparkling HydroTap G4 models



Classic

Arc / Cube

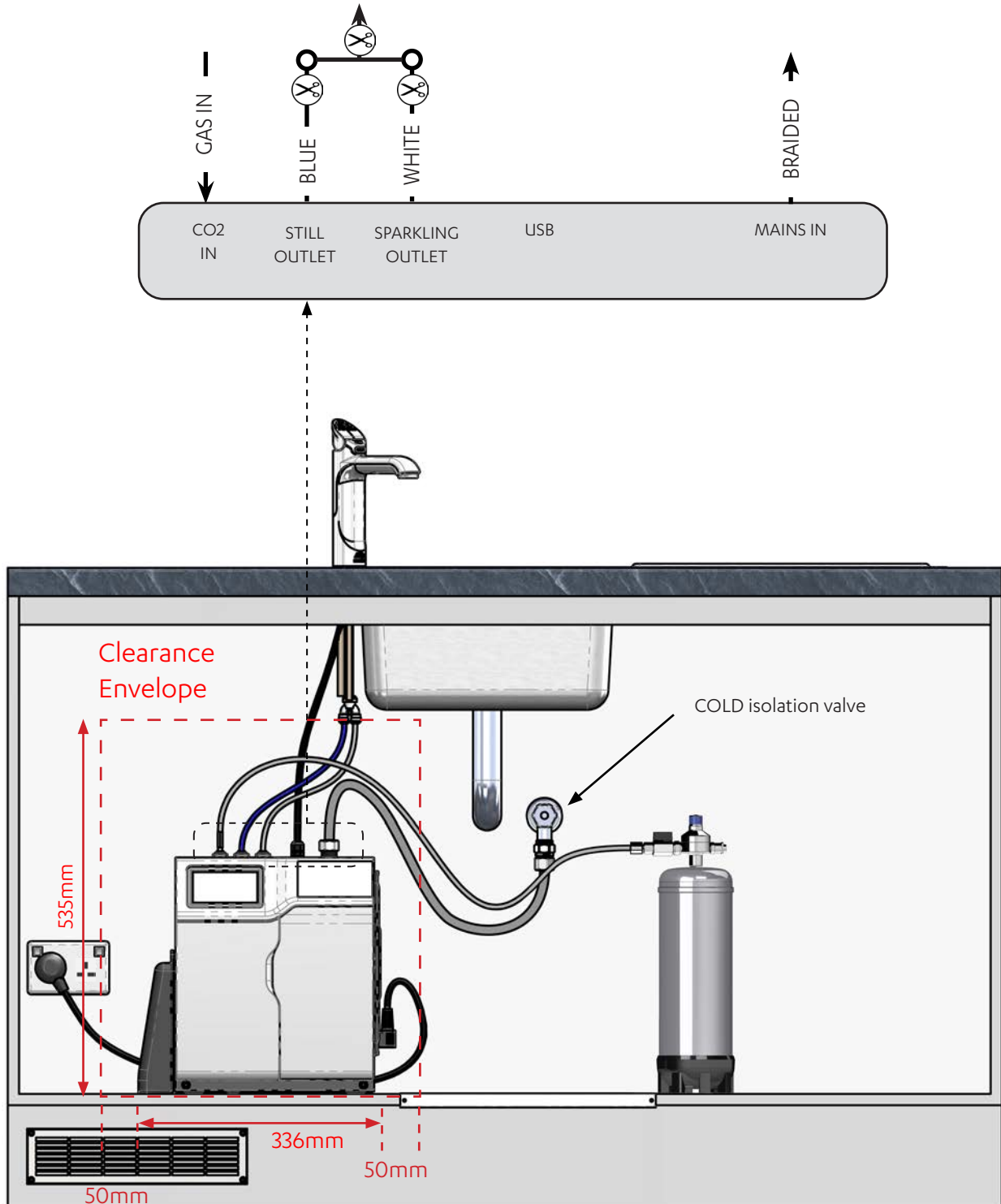

7.8.2 Chilled, sparkling and mixed hot & cold

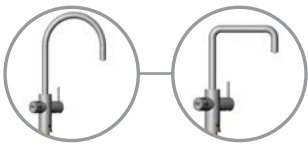

Celsius Arc

Celsius Cube

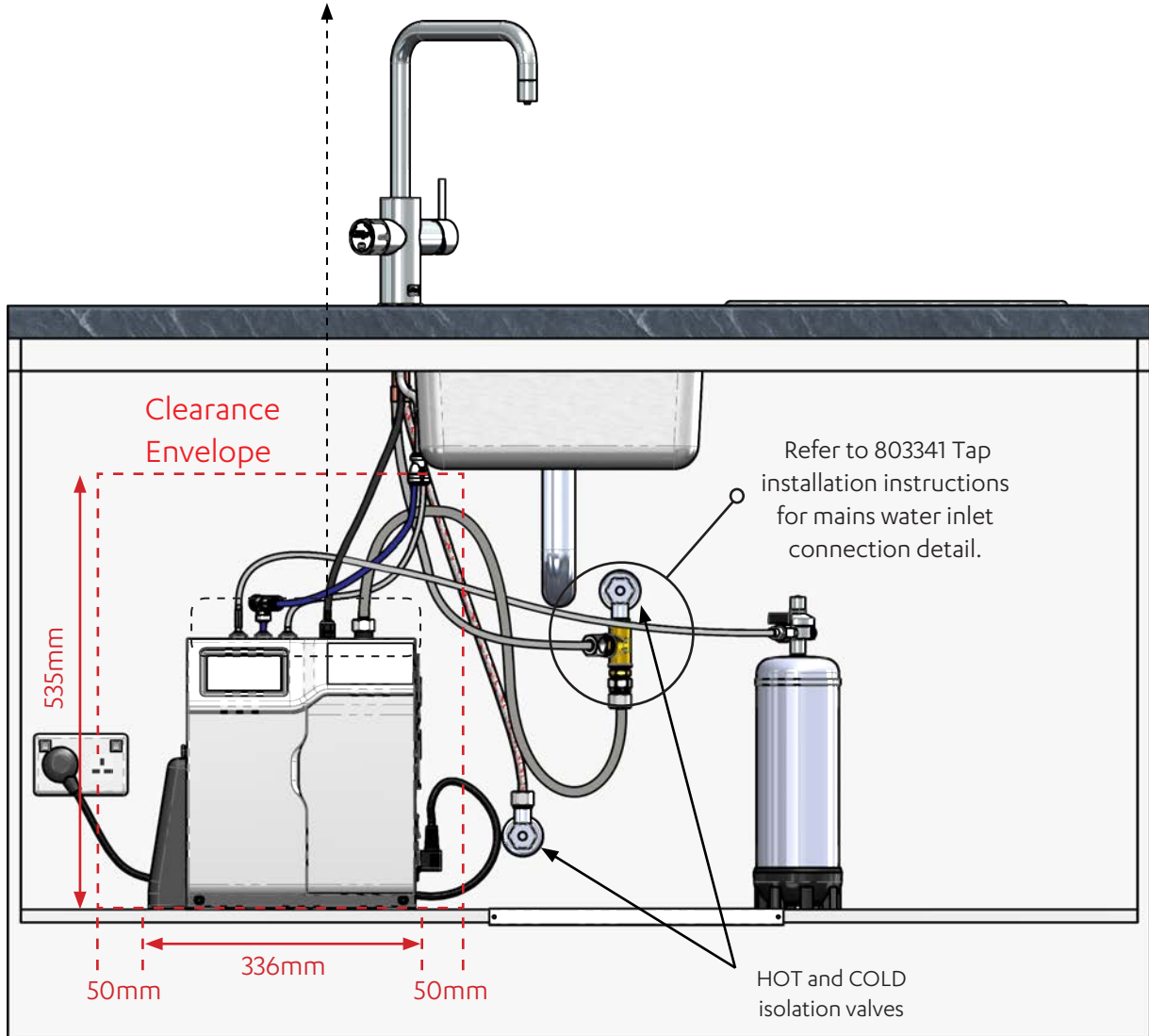
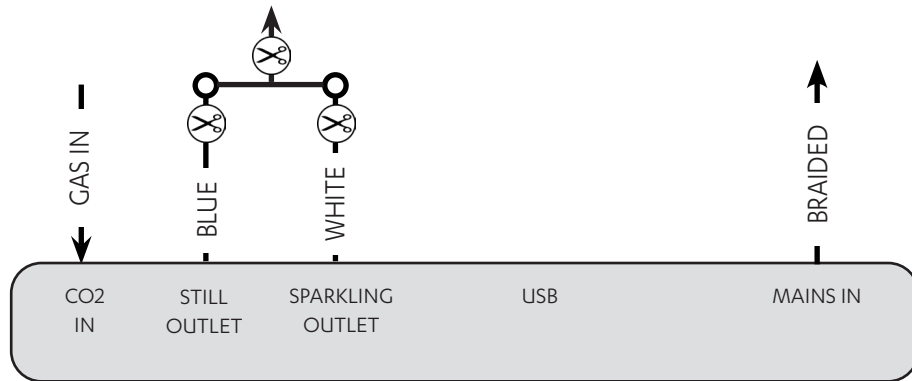

## 7.9 Command Centre installation

### 0061UK C Commercial

#### Table of contents

7.9.1 HydroTap models .....	65
7.9.2 Celsius models.....	66



### 7.9.1 HydroTap G4 Chilled models

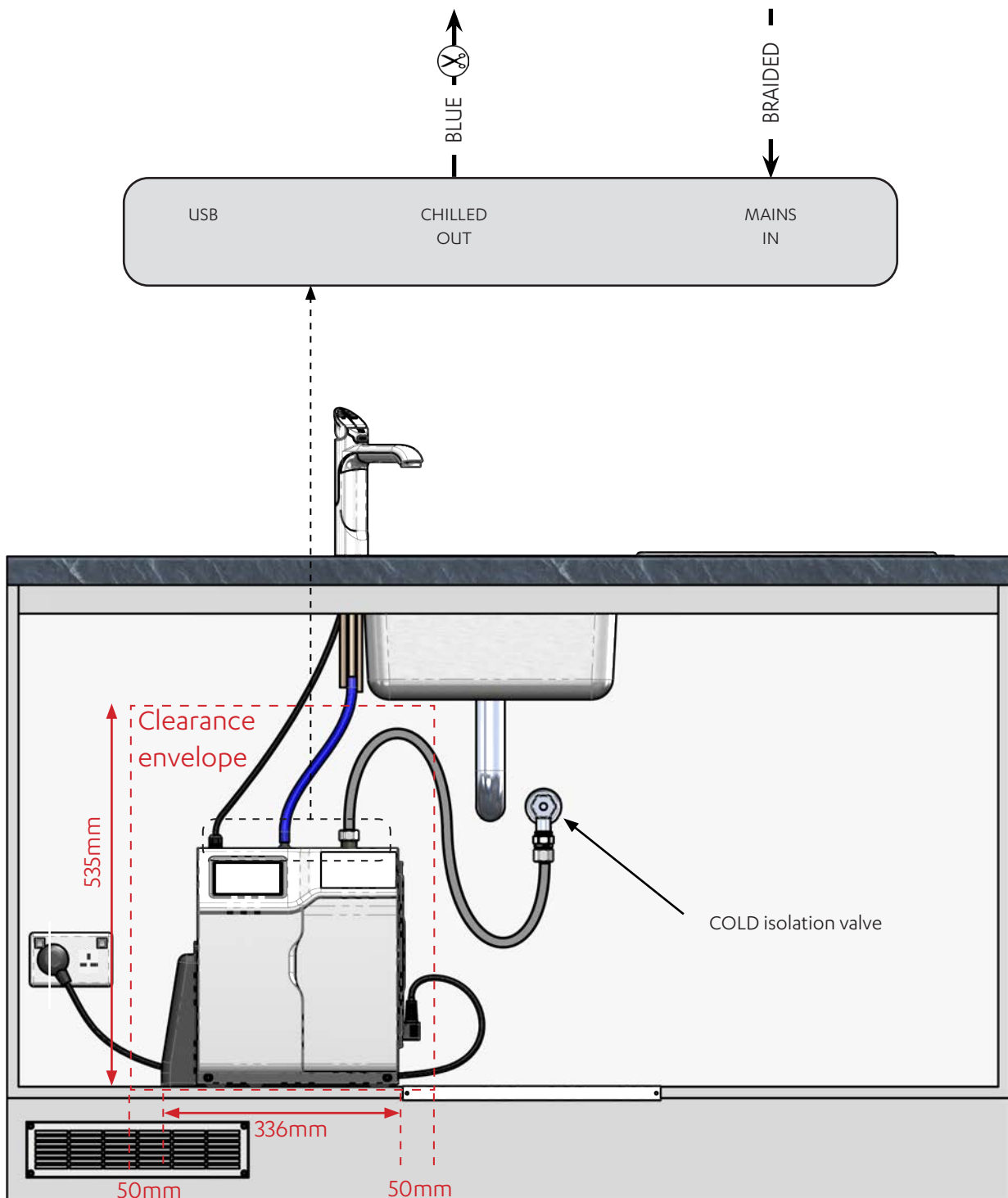

7.9.2 Chilled and mixed hot & cold models

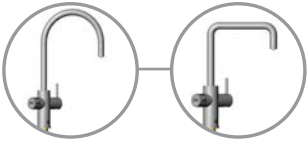

Celsius Arc Celsius Cube

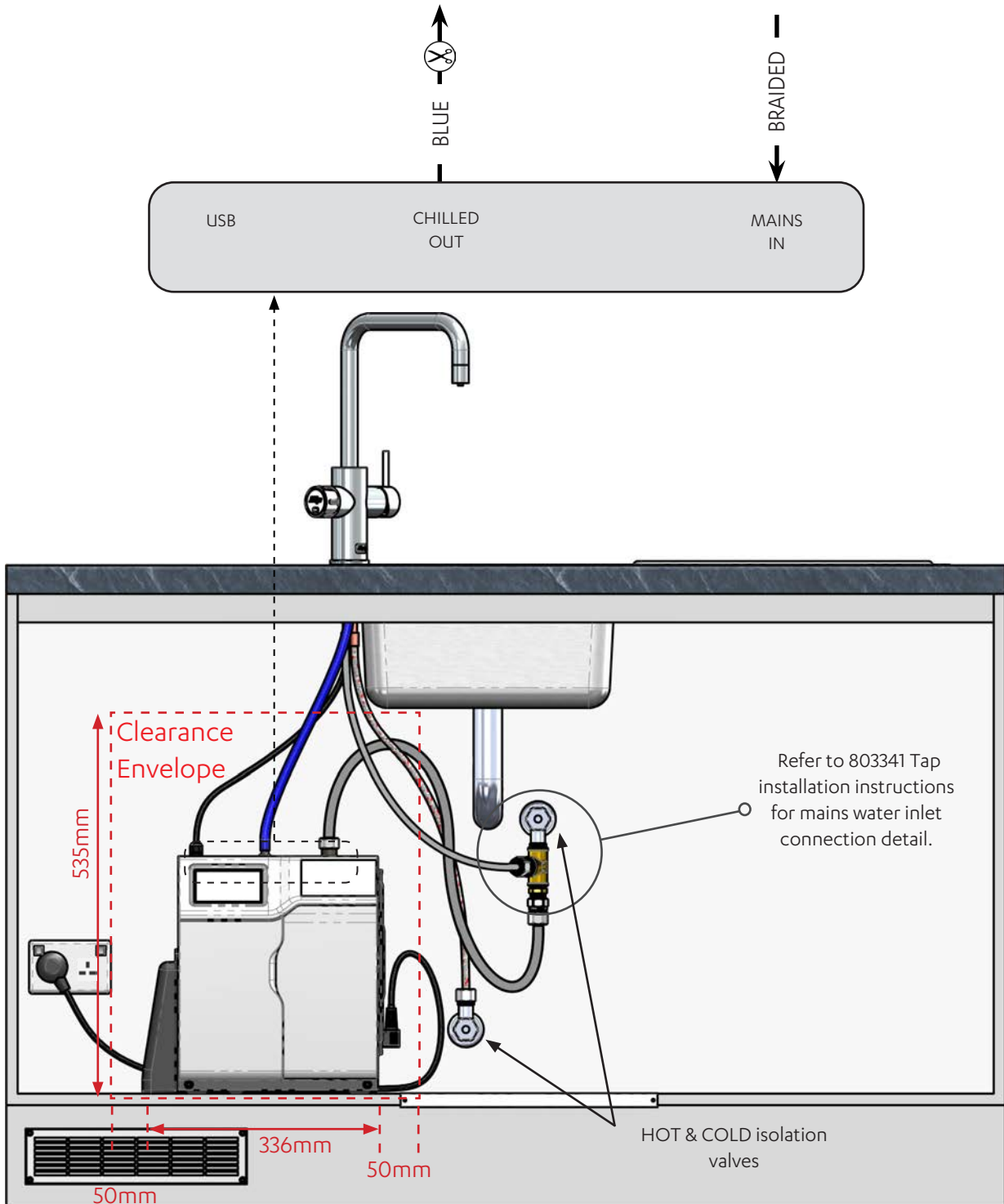

## Section 8

### Commissioning

#### 8.1 Warnings and precautions (also see Warnings and regulatory information, page 4)



##### **Do not fill until ready for use**

- For safe operation, the HydroTap G4 is designed to be installed, commissioned and used within 48 hours. Should the HydroTap G4 not be required for an extended period of time, 72 hours or more, do not fill and commission the HydroTap G4 until ready for first use.
- Ensure your HydroTap G4 is sanitised before use.
- If your HydroTap G4 is left idle before use, a filter change and sanitisation may be required.



##### **Sanitise during commissioning**

- All HydroTap G4 models with chilled; ambient and/or sparkling functionality must be sanitised during the commissioning process, please contact Zip on 0345 6 005 005 to book your free commissioning service.

#### 8.2 Basic guidelines



##### **Read these instructions before commencing Command Centre commissioning**

##### **Generic instructions**

- Do not commission your HydroTap G4 until ready for use.
- Turn the power and water on and check for any leaks.
- If fitted, ensure the booster is turned off. (The booster is commissioned later, see page 69).
- Familiarise yourself with the operation of the tap, in preparation for use, see the user guide.
- Follow the installation instructions below (and read section C of the user guide).
- After commissioning, the system may be customised by selecting further options in section G - settings of the user guide.

### 8.3 Select the language

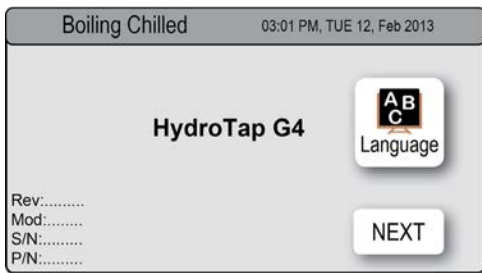

Initial commissioning screen



Language selection screen

### 8.4 CO<sub>2</sub> purge (sparkling models only)

- Once the language is set the commissioning program will move to the CO<sub>2</sub> section.
- In the next screen, press the [START] button to commence the purging process.
- You will hear the CO<sub>2</sub> gas running through the tap.
- Run for 10 seconds to fully purge the CO<sub>2</sub>.
- Press the [STOP] button to stop the purge.
- Press [Next] for filter flush screen.



### 8.5 Filter flush

Have a bucket or similar container (not supplied) at the ready to hold a quantity of water that will be ejected while the filter flush mode is in operation. Open the filter access door on the front of the HydroTap G4 and the filter cartridge will be exposed. Located to the rear right hand side of the cartridge is a flush line, approx 600mm long and the flush line stop cock. Place the free end of the flush line into the bucket or container (not supplied). **Note** At first commissioning, the system will select the filter flush screen automatically.

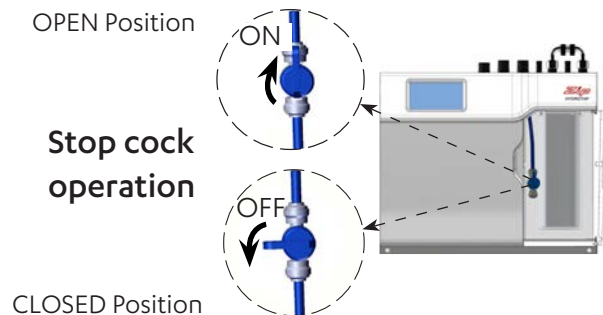

- Press [START] / [STOP] button to start and stop the filter flush.
- Turn the flush stop cock on.
- Allow at least 10 litres of water to flush through the filter.
- Once the filter flush is finished, turn the stop cock off then press [STOP] to end filter flush mode.
- Press [NEXT] for the boiling calibration screen.

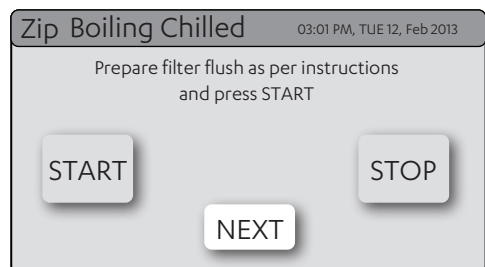

### 8.6 Boiling calibration (boiling models only)

- Press the [Calibrate] button and the system will start the boiling calibration procedure. This will take approx. 5 to 6 minutes.

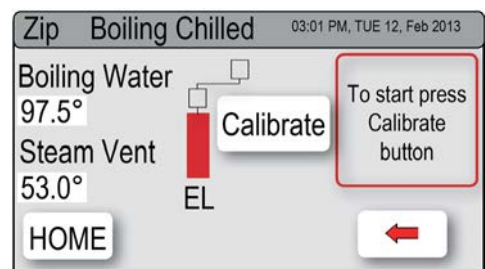

### 8.7 To enable a booster (when installed)

- Press the [MENU] button for main menu.
- Press the [Install] button.
- Press the [Boost] button.
- In the next screen, select [YES] to enable the booster.
- Before connecting the power to the booster, water must be run through for a min. of 30 seconds to purge. Run the boiling tap for 30 seconds and then allow the tank to refill.
- Dispense boiling water for 30 seconds and check the booster outlet hose is warm when the boiling water tank is replenishing.

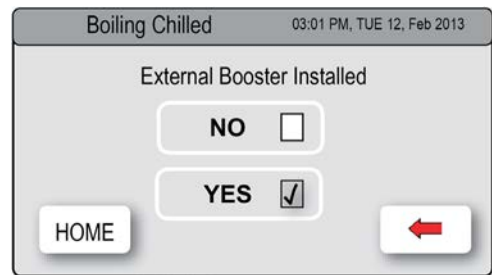

**Note** Depending on your location you may need to reset the internal clock. See section G of the user guide to reset the date and time.

**Note** For any subsequent filter changes or any operational procedures, please refer to the HydroTap G4 user guide, located inside the filter housing access door.

### 8.8 Safety sensor calibration (boiling models)

Light intensity varies from site to site, therefore it is recommended that a re-calibration be performed at the time of the installation. All direct sunlight must be shaded from the HydroTap G4, during the calibration. This can be achieved by closing any nearby curtains, blinds, etc.

- Shield the HydroTap G4 from direct sunlight.
- In normal operating mode. Turn the power off.
- Pull both tap levers to the forward position.
- Turn the power on.
- The safety sensor will calibrate.
- Return the levers to the neutral position.

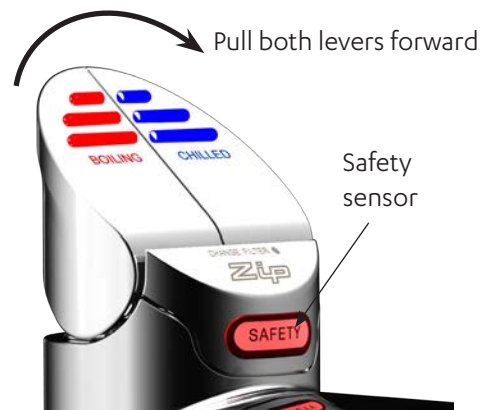

### 8.9 System flush



**WARNING!** Ensure all sanitising residue is flushed out prior to use.

When the filter flush and calibration have been completed, flush the system of trapped air and sanitisation residue by dispensing water from the tap until it flows without any further spluttering.

#### 8.9.1 Boiling and boiling ambient Command Centres

- Dispense 3 litres of water from the boiling outlet of the HydroTap. Equivalent of a complete tankful of water.

#### 8.9.2 Boiling chilled Command Centres

- Dispense 3 litres of water from the boiling outlet of the HydroTap. Equivalent of a complete tankful of water.
- Dispense 6 litres of chilled water from the chilled outlet of the HydroTap. Equivalent of two complete tankfuls of water.

### 8.9.3 Boiling chilled sparkling Command Centres

- Turn off CO<sub>2</sub> gas at the regulator.
- Dispense 3 litres of water from the boiling outlet of the HydroTap. Equivalent of a complete tankful of water.
- Dispense 1 litres of water from the chilled outlet, then 2 litres of water from the sparkling outlet, then repeat both dispenses. (Total of 2 litres of chilled and 4 litres of sparkling).
- Turn on the CO<sub>2</sub> gas at the regulator.

### 8.9.4 Chilled sparkling Command Centres

- Turn off CO<sub>2</sub> gas at the regulator.
- Dispense 1 litres of water from the chilled outlet, then 2 litres of water from the sparkling outlet, then repeat both dispenses. (Total of 2 litres of chilled and 4 litres of sparkling).
- Turn on the CO<sub>2</sub> gas at the regulator.

### 8.9.5 Chilled Command Centres

- Dispense 6 litres of chilled water from the chilled outlet. Equivalent of two complete tankfuls of water.

### 8.9.6 Check

- Check that the water is clear, and that there are no bubbles or foam present in the dispensed water.

System fault message	Possible cause	Solutions
Power Board Fault	Electrical disruption	Check power supply and all fuses
Interface Fault	Internal fault	Call Zip After Sales
Level Board Fault	Internal fault	Call Zip After Sales
Condenser Screen Blocked	Blocked air filter	Remove blockage / clean filter / check user guide
Water leak, Isolate Mains	Water leak	Turn off mains water supply / Call Zip After Sales
Compressor Over Run	Compressor too hot	Check ventilation
Water Supply Failure	No water	Check water supply is turned on
Hot Sensor Open	Internal fault	Call Zip After Sales
Hot Sensor Closed	Internal fault	Call Zip After Sales
Cold Sensor Open	Internal fault	Call Zip After Sales
Cold Sensor Closed	Internal fault	Call Zip After Sales
Flood Sensor Open	Internal fault	Call Zip After Sales
Condenser Sensor Closed	Internal fault	Check ventilation / Call Zip After Sales
Condenser Sensor Open	Internal fault	Check ventilation / Call Zip After Sales
Heater Driver Fault	No hot water	Call Zip After Sales
Compressor. Driver Fault	No chilled water	Call Zip After Sales
Hot Sensor Degraded	Internal fault	Call Zip After Sales
A DC Pump is faulty	Internal fault	Call Zip After Sales
Condenser Overtemp	Blocked air filter	Remove blockage / Clean filter / check user guide
Steam too Cool	Internal fault	Call Zip After Sales
Steam Sensor Open	Internal fault	Call Zip After Sales
Steam Sensor Closed	Internal fault	Call Zip After Sales
Hot Overload	Internal fault	Turn off to reset / Call Zip service
Hot Tank Overfilled	Internal fault	Call Zip After Sales
Comp Fuse/Driver Fault	Internal fault	Call Zip After Sales
Hot tank under filled	Low water pressure	Check water supply
Boil dry protection	Safety activated	Turn OFF / On power to reset
Flash Mem corrupted	Internal fault	Call Zip After Sales
Flow Sensor Fault	Internal fault	Call Zip After Sales

Call an electrician, a plumber, or Zip on 0345 6 005 005 for assistance, service, spare parts or enquiries.

### General Maintenance

- Zip offers a fully inclusive service plan, our HydroCare Service Plan will take care of all routine maintenance, including filter replacements, sanitisation, electrical safety inspections as well as general maintenance of your HydroTap, please visit [specify.zipwater.co.uk/HydroCare](https://specify.zipwater.co.uk/HydroCare) for more information.
- The Zip filter should be replaced as recommended on the filter, or earlier if you notice a persistent reduction in water flow from the tap or an unpleasant taste or odour in the water.
- For safe operation, flush the HydroTap after periods of non-use longer than 72 hours, for at least 60 seconds.

## Trouble shooting and general maintenance

- Not changing the filter cartridges when required may affect the water quality.
- Sanitisation should be carried out at all filter changes, or at intervals of no more than 12 months.
- Cleaning of the tap and dispensing outlets must only be undertaken with alcohol wipes. Chemicals should NOT be sprayed onto the tap at any time.
- Never use strong, corrosive or abrasive cleaning materials on the Zip HydroTap or Command Centre.

## End of life disposal



The use of this crossed out wheeled bin logo indicates that this product needs to be disposed of separately to any other household waste.

Within each of the European Union member countries, provisions have been made for collection and recycling of unwanted electrical and electronic equipment. In order to help preserve our environment we ask that you dispose of this product correctly. Please contact Zip Customer Service on 0345 6 005 005 for advice.



Our goods and services are supplied in accordance with our standard terms and conditions. This policy sets out the warranty period and exclusions which apply to the G4 HydroTap. This policy is subject to our standard terms and conditions and should be read in conjunction with those terms, particularly clause 5 of the terms and conditions.

### Warranty

The warranty period for the G4 HydroTap tank is 5 years. Any part is 2 years.

Subject to the exclusions set out below and in clause 5 of the terms and conditions, faulty parts and products will be replaced or repaired free of charge by Zip, its distributor or service provider, where such faults arise during the applicable warranty period.

### Exclusions

1. This policy only applies where:

(i) The product is installed and used strictly in accordance with the terms and conditions and the instructions supplied with the product; and

(ii) The failure is not due to accident, misuse, abuse, unsuitable water conditions (including contaminants or inappropriate water pressure), or to any alteration, modification or repair by any party not expressly nominated by Zip.

2. This warranty does not cover damage resulting from non-operation of the product or consequential damage to any other goods, furnishings or property.

3. This warranty does not apply to any consumables.

4. Zip residential (for home) products are designed specifically for use in a domestic, residential location.

Inappropriate installations, such as in a commercial environment (including residential care homes or medical facilities), will invalidate the warranty.

### Service Work

Ad hoc repairs by Zip or its approved service providers are covered under Warranty for 30 days in relation to the original fault only.

If you are a HydroCare Service Plan subscriber please refer to the HydroCare terms and conditions for information on applicable warranties and warranty periods for HydroCare services.

### Registering your purchase

Registering your Zip installation on the Zip website may help to establish date of installation should it become necessary to service the G4 HydroTap under terms of the Zip warranty. To register your installation visit [www.zipwater.co.uk/product-registration](http://www.zipwater.co.uk/product-registration).

Our goods and services are supplied in accordance with our standard terms and conditions. This policy sets out the warranty period and exclusions which apply to the G4 HydroTap. This policy is subject to our standard terms and conditions and should be read in conjunction with those terms, particularly clause 5 of the terms and conditions.

### Warranty

The warranty period for the G4 HydroTap tank is 5 years. Any part is 3 years.

Subject to the exclusions set out below and in clause 5 of the terms and conditions, faulty parts and products will be replaced or repaired free of charge by Zip, its distributor or service provider, where such faults arise during the applicable warranty period.

### Exclusions

1. This policy only applies where:

(i) The product is installed and used strictly in accordance with the terms and conditions and the instructions supplied with the product; and

(ii) The failure is not due to accident, misuse, abuse, unsuitable water conditions (including contaminants or inappropriate water pressure), or to any alteration, modification or repair by any party not expressly nominated by Zip.

2. This warranty does not cover damage resulting from non-operation of the product or consequential damage to any other goods, furnishings or property.

3. This warranty does not apply to any consumables.

4. Zip residential (for home) products are designed specifically for use in a domestic, residential location.

Inappropriate installations, such as in a commercial environment (including residential care homes or medical facilities), will invalidate the warranty.

### Service Work

Ad hoc repairs by Zip or its approved service providers are covered under Warranty for 30 days in relation to the original fault only.

If you are a HydroCare Service Plan subscriber please refer to the HydroCare terms and conditions for information on applicable warranties and warranty periods for HydroCare services.

### Registering your purchase

Registering your Zip installation on the Zip website may help to establish date of installation should it become necessary to service the G4 HydroTap under terms of the Zip warranty. To register your installation visit [www.zipwater.co.uk/product-registration](http://www.zipwater.co.uk/product-registration).





Zip Water UK  
14 Bertie Ward Way, Dereham, Norfolk NR19 1TE  
0345 6 005 005 sales@zipindustries.co.uk

[www.zipwater.co.uk](http://www.zipwater.co.uk)